

# INSTALLATION INSTRUCTIONS

## EA-8 CONTROLLER



**SoundOff**  
**Signal** ®

**IMPORTANT NOTICE TO INSTALLER:**

- Make sure to read and understand all instructions and warnings before proceeding with the installation of this product. Ensure the manual and all warning cards are delivered to the end user of this equipment.
- HIGH CURRENT interconnects must be properly terminated. Poor crimp quality can cause heat build-up and fire. Follow crimp connector manufacturer instructions.
- DO NOT use system to disconnect headlights, brake lights or other safety equipment.
- Unit may become hot to touch during normal operation.
- Failure to properly install connectors, fuses or wiring may cause vehicle failure or fire.
- Installation must only be performed by trained technician. Installer must determine vehicle wiring configuration and proper integration of system.
- Use proper wire gauge. All power wires connecting to positive (+) or negative (-) battery terminal or local chassis ground (-) must be sized to supply at least 125% of max. current and properly fused at power source.
- Install protective grommets when routing wire through firewall or metal.

**⚠ WARNING**

- DO NOT install this product or route its wires in the air bag deployment area. Doing so may cause damage to or reduce effectiveness of the air bag, or create projectile that could cause serious injury or death. To determine air bag deployment area refer to vehicle manufacturer's manual.

**NOTICE:**

- Installers and users must comply with all applicable federal, state and local laws regarding use and installation of warning devices.
- Improper use or installation may void warranty coverage.
- To review our Limited Warranty Statement & Return Policy for this or any SoundOff Signal product, visit our website at <https://soundoffsignal.com/warranty>.
- If you have questions regarding this product, contact Technical Services, Monday - Friday, 8 a.m. to 5 p.m. ET at 1.800.338.7337 (press #4).
- Questions or comments that do not require immediate attention may be emailed to [techgroup@soundoffsignal.com](mailto:techgroup@soundoffsignal.com).

# Table of Contents

Warning ..... 2

Contents ..... 4

Technical Specifications ..... 4

Mounting ..... 5

    Screw Mount Bracket ..... 5

    Power Module ..... 5

    Decal Placement ..... 5

Wiring ..... 6

Programming & Operation ..... 7

    General Operation for Programming Mode ..... 7

    Standby Mode ..... 8

    Default Configuration of Buttons ..... 8

    Scene 1 and Scene 2 Controlled by B5 and B6 ..... 9

    Programming Mode 1 ..... 10

    Programming Mode 2 ..... 16

    Button Combo: Group 1 ..... 20

    Button Combo: Group 2 ..... 20

    Button Combo: Group 3 ..... 20

    EA-8 Duplicator Operation Instructions ..... 20-21

Warranty & Goods Procedure ..... 22

CONTENTS		
NO.	COMPONENT	QTY.
1	POWER MODULE	1
2	CONTROLLER	1
3	RJ45 CABLE (4M)	1
4	TERMINAL BLOCK	1
5	SELF-DRILLING SCREW (#8x1")	4
6	6-PIN WIRE HARNESS	1
7	ADJUSTABLE SCREW MOUNT BRACKET	1
8	SELF-DRILLING SCREW (4X15MM)	2
9	DECALS	1
10	INSTRUCTION CARD	1

TECHNICAL SPECIFICATIONS	
Control Panel Dimensions:	68.8mm H x 96.9mm W x 25.5mm D
Power Module Dimensions:	100.9mm L x 91.8mm W x 26.4mm H
Input Voltage:	10 - 30VDC (negative ground)
Input Current:	45A Max Total Combined
Standby Current:	<35mA
Operating Temperature:	-40°C to +60°C
Number of Positive Outputs:	8
Number of Negative Outputs:	2
Max Current / Positive Outputs:	1x 15A, 2x 10A, 1x 10A (for Output 4~8)
Max Current / Negative Outputs:	2x 2A
Fuse Rating:	50A (user-supplied)
Cable Length:	6-pin wire harness: 30cm RJ45 cable: 4m
Certifications:	ECE R10

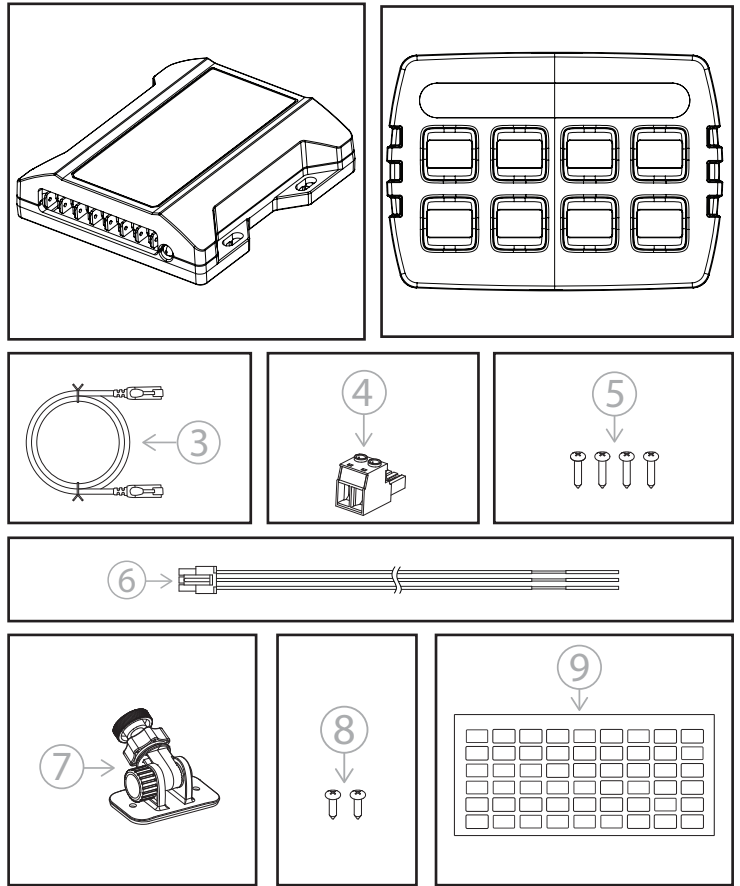

## MOUNTING

### Screw Mount Bracket

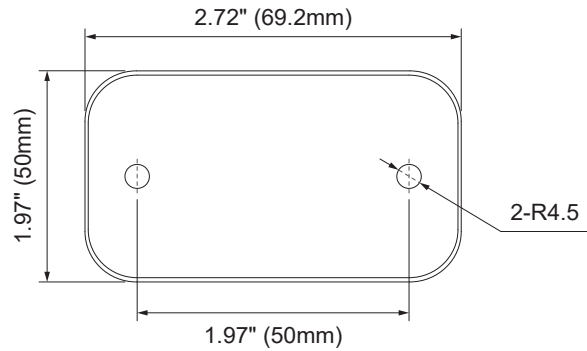
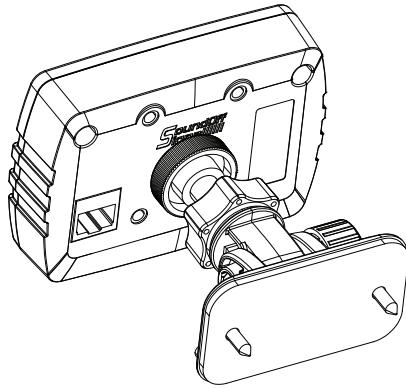

1. Choose a desired place for installation.
2. Use the base as the template to locate and mark two mounting holes on the mounting surface.
3. Secure the bracket with the two Ø4 self-drilling screws supplied.
4. Assemble the controller with the bracket by tightening the knurled knob in a firm way.
5. Adjust the bracket at an angle most convenient to your operation.

### Power Module

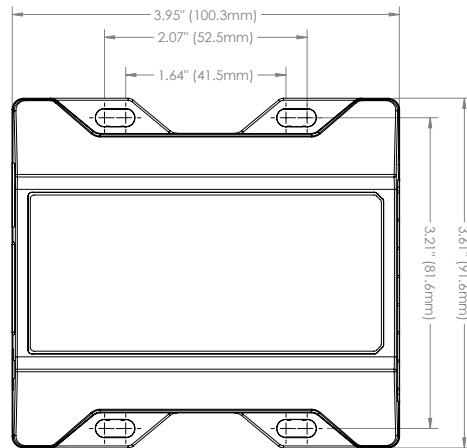
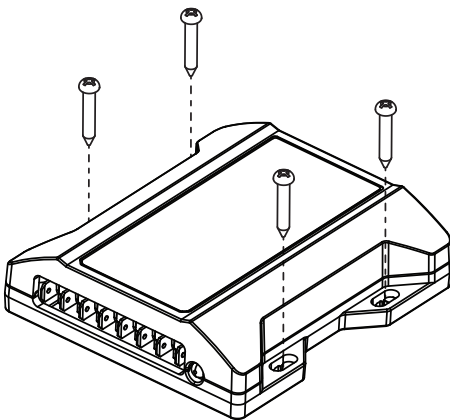

1. Choose a flat surface to install the power module.
  2. Use the power module as the template to locate and mark four mounting holes on the mounting surface.
  3. Secure the power module with the four #8 self-drilling screws supplied.
- NOTE:** Always install the power module away from a heat source

### Placement of Decals

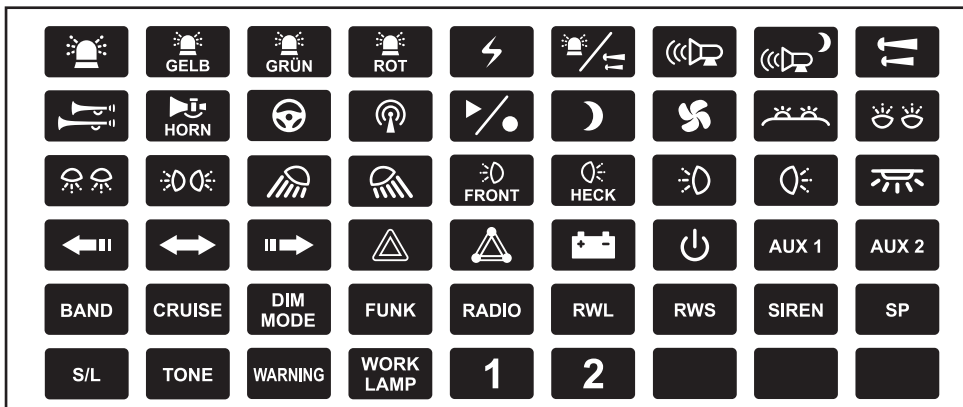

1. The controller is shipped without any button decals installed.
2. After assembling the controller and the mounting bracket, apply a desired decal above each button to facilitate subsequent programming and operation.

**WIRING**

**Power Module**

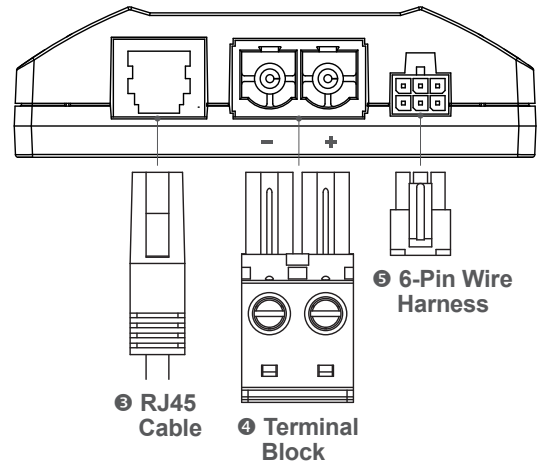
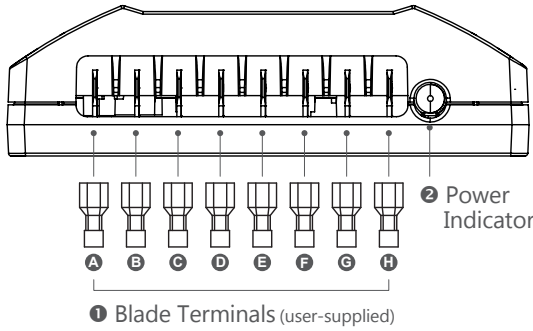

CONTENTS		
NO.	COMPONENT	
1	BLADE TERMINALS	
1A	POSITIVE OUTPUT 1 (MAX. 15A)	
1B	POSITIVE OUTPUT 2 (MAX. 10A)	
1C	POSITIVE OUTPUT 3 (MAX. 10A)	
1D	POSITIVE OUTPUT 4	TOTAL CURRENT OF OUTPUT 4~8 IS 10A MAX
1E	POSITIVE OUTPUT 5	
1F	POSITIVE OUTPUT 6	
1G	POSITIVE OUTPUT 7	
1H	POSITIVE OUTPUT 8	
2	POWER INDICATOR	
3	RJ45 CABLE	
4	TERMINAL BLOCK	
5	6-PIN WIRE HARNESS	

**6-Pin Wire Harness Pinout**

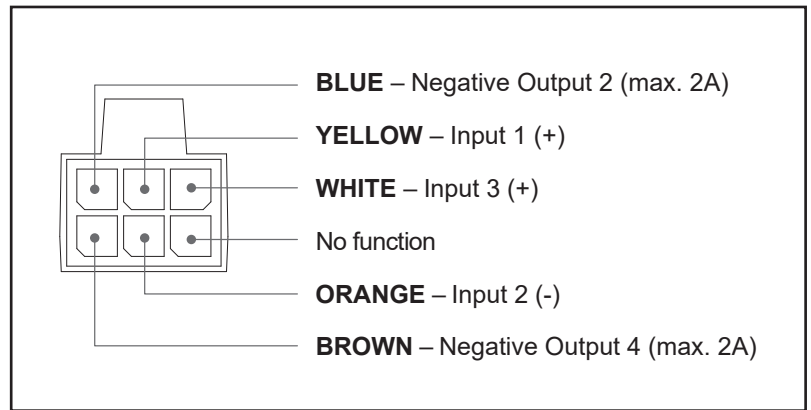

**Output Overload & Short Circuit Protection:**

**B1:** If total load current from output 1 exceeds 15A, B1 will turn OFF, Green LED on B1 & 10 Amber TA LEDs will single flash and Beeper will sound together to show Overload or Short Circuit status. The EA-8 Controller will be locked out and must be RESET to use.

**B2:** If total load current from output 2 exceeds 10A, B2 will turn OFF, Green LED on B2 & 10 Amber TA LEDs will single flash and Beeper will sound together to show Overload or Short Circuit status. The EA-8 Controller will be locked out and must be RESET to use.

**B3:** If total load current from output 2 exceeds 10A, B3 will turn OFF, Green LED on B3 & 10 Amber TA LEDs will single flash and Beeper will sound together to show Overload or Short Circuit status. The EA-8 Controller will be locked out and must be RESET to use.

**B4~B8:** If combined loads from outputs 4-8 exceed 10A, B4~B8 will turn OFF, Green LED on B4~B8 & 10 Amber TA LEDs will single flash and Beeper will sound together to show Overload or Short Circuit status. The EA-8 Controller will be locked out and must be RESET to use.

**B2 & B4 (Negative Outputs):** If there is a short circuit on either Negative output 2 or 4, B2 or B4 respectively will turn OFF, Red LED on B2 or B4 & 10 Amber TA LEDs will single flash and Beeper will sound together to show Overload or Short Circuit status. The EA-8 Controller will be locked out and must be RESET to use.

**To RESET Overload Status:**

Soft Reset:

1. Press & HOLD button B4 for 2 seconds to reset.
2. Fix Overload or short circuit condition on load/s,
3. Reactivate output to test.

Hard Reset:

1. Remove Power from the Power Module.
2. Fix the overload or short circuit condition on the load/s.
3. Reconnect Power to the Power Module and test all outputs ON at the same time to ensure the overload condition is fixed.

## GENERAL OPERATION FOR PROGRAMMING MODE

### Programming Mode 1 and Programming Mode 2

- EA-8 Controller has two programming modes.
- Programming Mode 1 allows you to configure B1~B8 and the settings of each input.
- Programming Mode 2 allows you to configure the Traffic Arrow function, input configuration of Traffic Arrow, Standby Mode, B4 flashing mode under Standby Mode and Buzzer ON/OFF configuration.
- You can also reset to factory default configuration in Programming Mode 2.

### Programming Mode 1 and Programming Mode 2

- Press B1 and B3 for more than 1 second to enter Programming Mode 1 (See page 10).
- Press B2 and B4 for more than 1 second to enter Programming Mode 2 (See page 16).

**NOTE:** The indicator light in the upper right corner will flash in single flash for Mode 1, or double flash for Mode 2.

**Mode 1: Single Flash**

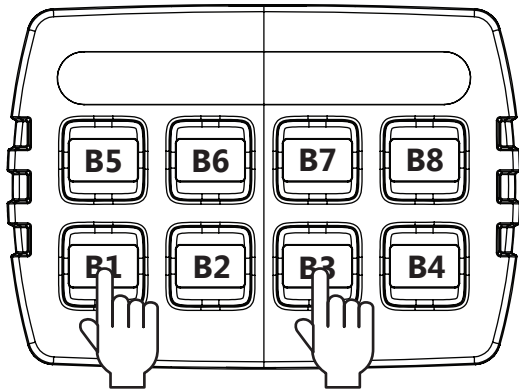

**Mode 2: Double Flash**

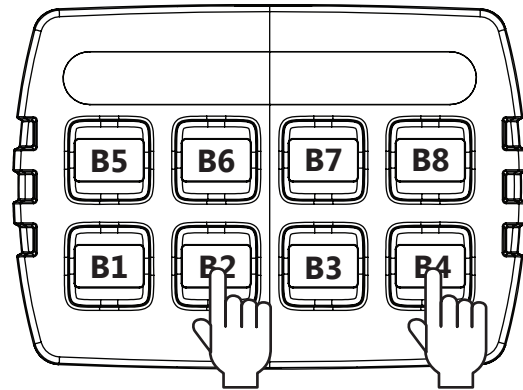

### Change Setting Value

1. Press B1 and B3 for more than 1 second to enter Programming Mode 1.
2. Press the button you would like to configure. The indicator light at the upper left corner will be lit up to indicate the current setting (1 light = Setting #1, 2 lights = Setting #2... and so on).
3. Press the button again to go to the next setting. The indicator light will show the current setting according the rule mentioned above.
4. Press B1 and B3 for more than 1 second to exit and save your configuration.

### Error Signal

Under Programming Mode 1 or Mode 2, when you program a button with the function cannot be activated (e.g. B1 has been set as a permanent switch. Configure B3 to activate B1 automatically), an error occurs and the green backlight will flash three times on those buttons with three "beep" sounds.

### Reset to Factory Default Configuration

1. Press B2 and B4 for more than 1 second to enter Programming Mode 2.
2. Press and hold B3 and B4 for more than 5 seconds.
3. If EA-8 Controller has been restored to factory default configuration successfully, the controller will return to operation mode (after "beep" for three times and green backlight is ON).

### Automatic Standby Mode (default configuration)

Automatically enter Standby Mode after 15 minutes if no buttons are activated and Input 1 is not activated either (Refer to Programming Mode 2, page 17, for detailed information of Standby Mode Configuration).

**NOTE:** After entering Standby Mode, Programming Mode CANNOT be accessed by default. If you want to enter Programming Mode, disconnect all power and reboot your EA-8 Controller.

### Testing Mode (for factory users only)

1. Enter Programming Mode 2.
2. Press and hold B7 and B8 for more than 3 seconds.
3. Under Testing Mode, you can test the connection of Input 1 / Input 2 / Input 3 respectively.
4. After finishing testing, disconnect all power to exit Testing Mode.

**NOTE:** Testing Mode is accessible ONLY under Factory Default Configuration.

## STANDBY MODE

### Enter Standby Mode Automatically (default configuration)

Automatically enter Standby Mode after 15 minutes if no buttons are activated and Input 1 is not activated either.

### Enter Standby Mode Manually (default configuration)

- Manually enter Standby Mode by pressing B4 for more than 1 second.
- It will turn off all button functions. (Refer to Programming Mode 2, page 17, for detailed information of Standby Mode Configuration)

**NOTE:** After entering Standby Mode, Programming Mode CANNOT be accessed by default. If you want to enter Programming Mode, disconnect all power and reboot your EA-8 Controller.

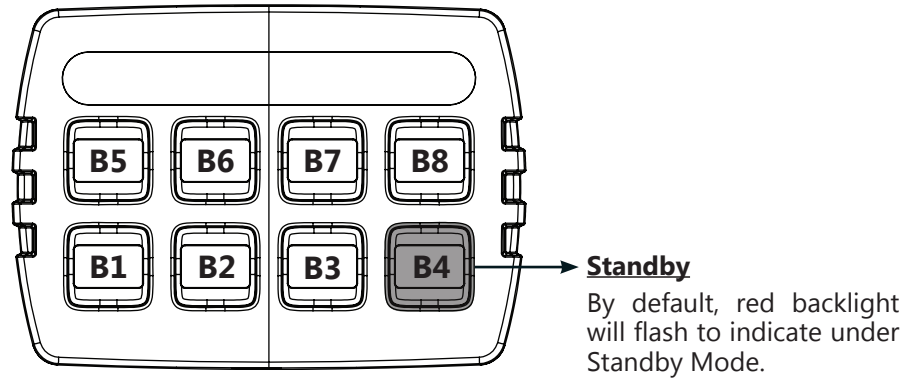

## DEFAULT CONFIGURATION OF BUTTONS

### B1 = POSITIVE OUTPUT 1

#### ON/OFF Switch

- Activate B1 will activate the main warning light.
- When B1 (main warning light) is interlocked by B2 (siren), it is possible to activate B1 by pressing B2.
- Also Input 3 can be connected to an external switch to activate B1 (main warning light) and B2 (siren).

### B2 = POSITIVE OUTPUT 2 & NEGATIVE OUTPUT 1

#### Siren Interlock w/ Siren Kill

- Connect Input 2 to handbrake.
- Activate B2 will activate the siren.
- Activate B2 (siren) will also activate B1 (main warning light) simultaneously.
- When B2 (siren) is activated, turn on Input 2 (handbrake) will deactivated B2 (siren) immediately.

### B3 = POSITIVE OUTPUT 3

#### Grill warning light kill w/o reverting

- Connect Input 2 to handbrake.
  - Activate B1 (main warning light) will activate B3 (grill warning light) simultaneously.
- NOTE:** B3 can be activated only when B1 is activated.
- When B3 is activated, turn on Input 2 (handbrake) will deactivated B3 immediately.

**NOTE:** B3 will not revert when input 2 (handbrake) is off.

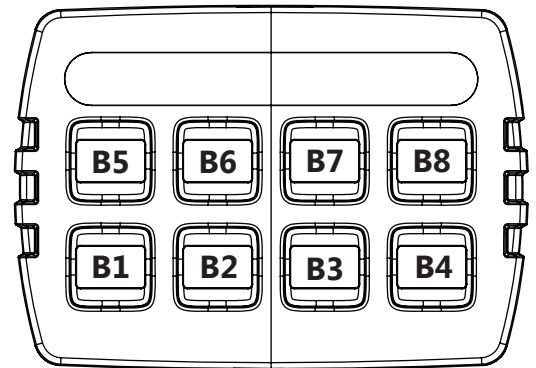



## B4 = POSITIVE OUTPUT 4 & NEGATIVE OUTPUT 2

### ON/OFF Switch

- Activate Positive Output 4 and Negative Output 2.

## B5 = POSITIVE OUTPUT 5

### ON/OFF Switch

- Activate Positive Output 5.

## B6 = POSITIVE OUTPUT 6

### ON/OFF Switch

- Activate Positive Output 6.

## B7 = POSITIVE OUTPUT 7

### ON/OFF Switch

- Activate Positive Output 7.

## B8 = POSITIVE OUTPUT 8

### ON/OFF Switch

- Activate Positive Output 8.

## TRAFFIC ARROW INDICATOR LIGHT

### No Function

- **NOTE:** If you want to configure Traffic Arrow Indicator Light, refer to Programming Mode 2 (See page 17) to conduct the setting operation.

## SCENE 1 AND SCENE 2 CONTROLLED BY B5 AND B6

### Scene Button Combo: Scene 1

- Under Programming Mode 1, you can set B5 as the start button of Scene 1.
- While B5 is activated, B1, B2, B3, B4 will be activated simultaneously.

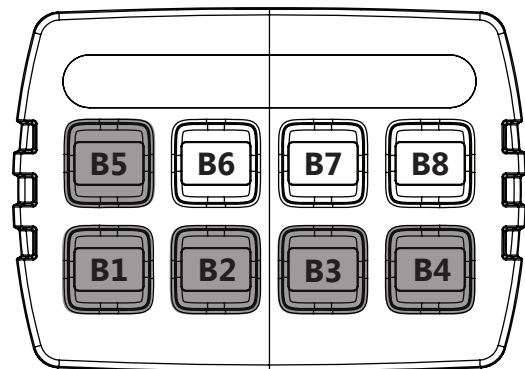
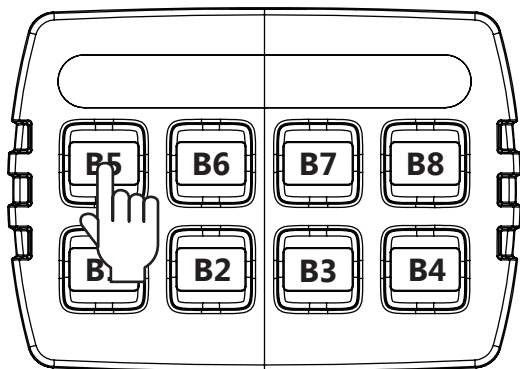

### Scene Button Combo: Scene 2

- Under Programming Mode 1, you can set B6 as the start button of Scene 2.
- While B6 is activated, B1, B3, B4 will be activated simultaneously (B4 can be added or removed in Scene 2 by B4 Setting under Programming Mode 1).

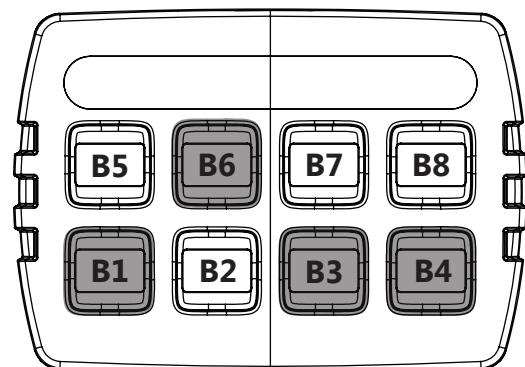
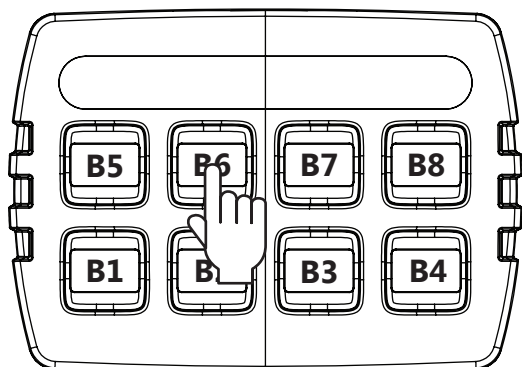

**PROGRAMMING MODE 1 (FOR SETTING B1~B8 BUTTON FUNCTION)****Setting Example: Programming Mode 1**

- Press B1 and B3 for more than 1 second to enter Programming Mode 1.

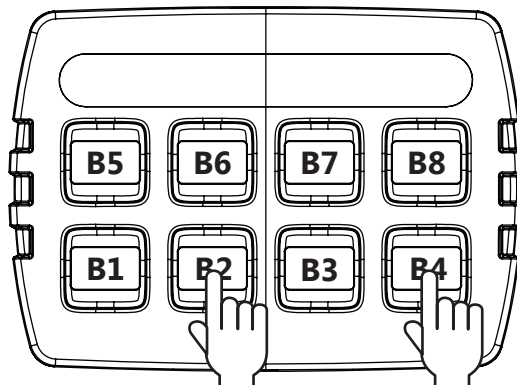

- Press B1 once, Setting #2 is currently selected. Press B1 again to go to Setting #3.

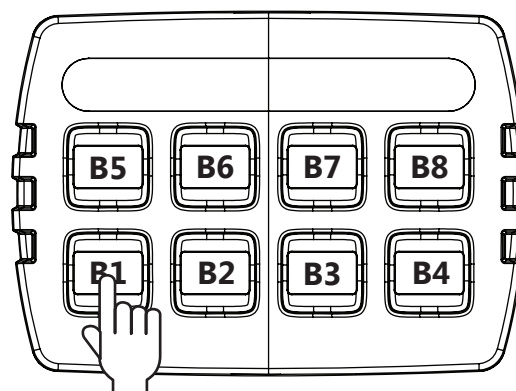
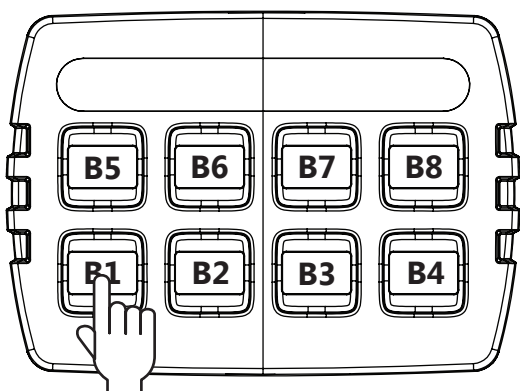

- After finishing setting, press B1 and B3 for more than 1 second to exit and save your configuration.

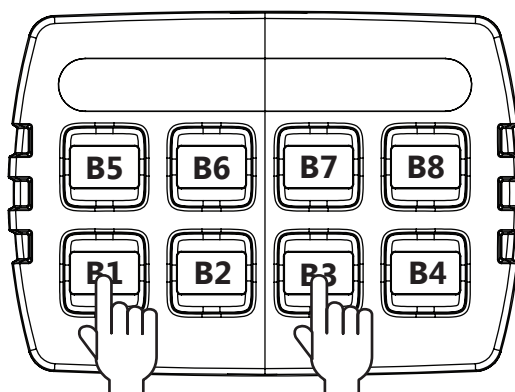

**B1 Setting (B1 controls Positive Output 1)**

- You can use B1 button as an ON/OFF switch that activates the main warning light. B1 may be interlocked by B2 (refer to B2 Setting, page 12).
- When B1 (main warning light) is interlocked by B2 (siren), it is possible to activate B1 by pressing B2.
- Also Input 3 can be connected to an external switch to activate B1 (main warning light) and B2 (siren).

Enter Programming Mode 1 and configure B1 Setting as the following table

#	INDICATOR LIGHT	DESCRIPTION
1	●○○○○○○○○●	Permanent switch, activated upon the power is ON
2 ★Default	●●○○○○○○○○●	ON/OFF switch
3	●●●○○○○○○○○●	Momentary switch
4	●●●●○○○○○○●	When B1 is activated, input 3 (warning light's status signal) is OFF, B1 will be deactivated after 4 seconds.
5	●●●●●○○○○○○●	When B2 is activated, input 3 (warning light's status signal) is OFF, B2 will be deactivated after 4 seconds.
6	●●●●●●○○○○●	Input 3 is connected to an external on/off switch. When the switch is ON, B1 and B2 will be activated. Turn off the switch will deactivate B2
7	●●●●●●●○○●	Input 3 is connected to an external momentary switch. Press the switch once to activate B1 and B2. Press the switch once again to deactivate B2.
8	●●●●●●●●○○●	Input 3 is connected to an external on/off switch. Only when B1 is activated, turn on the switch will activate B2. Turn off the switch will deactivate B2.
9	●●●●●●●●●●●	Input 3 is connected to an external momentary switch. Only when B1 is activated, press the switch once to activate B2. Press the switch once again to deactivate B2.

**B2 Setting (B2 controls Positive Output 2 and Negative Output 1)**

- You can use B2 button as an ON/OFF switch that activates the siren. And B2 may interlock B1, when B1 (main warning light) is interlocked by B2 (siren), it is possible to activate B1 by pressing B2.
- Also input 2 can be connected to handbrake or siren status signal to deactivate B2 (siren) for siren kill.

Enter Programming Mode 1 and configure B2 Setting as the following table

#	INDICATOR LIGHT	DESCRIPTION
1	●○○○○○○○○●	Permanent switch, activated upon the power is ON
2	●●○○○○○○●	ON/OFF switch
3	●●●○○○○●	Momentary switch
4 ★Default	●●●●○○○○●	<p><i>Siren Interlock w/ Siren Kill</i> Connect Input 2 to handbrake.</p> <ol style="list-style-type: none"> <li>1. Activate B2 (siren) will also activate B1 (main warning light) simultaneously.</li> <li>2. When B2 (siren) is activated, turn on Input 2 (handbrake) will deactivated B2 (siren) immediately</li> </ol>
5	●●●●●○○●	<p><i>Siren Interlock w/o Siren Kill</i></p> <ol style="list-style-type: none"> <li>1. Activate B2 (siren) will also activate B1 (main warning light) simultaneously.</li> <li>2. B2 is not affected by Input 2.</li> </ol>
6	●●●●●○○●	<p><i>Siren Interlock w/ Siren status detection</i> Connect Input 2 to siren status signal.</p> <ol style="list-style-type: none"> <li>1. Activate B2 (siren) will also activate B1 (main warning light) simultaneously.</li> <li>2. If Input 2 (siren status signal) is OFF, B2 will be deactivated automatically after 4 seconds.</li> </ol>
7	●●●●●●○○●	<p><i>Siren Interlock w/ Siren Kill</i> Connect Input 2 to handbrake.</p> <ol style="list-style-type: none"> <li>1. B2 (siren) can be activated only when B1 (main warning light) is activated.</li> <li>2. When B2 (siren) is activated, turn on Input 2 (handbrake) will deactivated B2 (siren) immediately.</li> </ol>
8	●●●●●●●○○●	<p><i>Siren Interlock w/o Siren Kill</i></p> <ol style="list-style-type: none"> <li>1. B2 (siren) can be activated only when B1 is activated (main warning light).</li> <li>2. B2 is not affected by Input 2.</li> </ol>
9	●●●●●●●●●	<p><i>Siren Interlock w/ Siren status detection</i> Connect Input 2 to siren status signal.</p> <ol style="list-style-type: none"> <li>1. B2 (siren) can be activated only when B1 is activated (main warning light).</li> <li>2. If Input 2 (siren status signal) is OFF, B2 will be deactivated automatically after 4 seconds</li> </ol>

**B3 Setting (B3 controls Positive Output 3)**

- You can use B3 button as an ON/OFF switch that activates grill warning light and it can be activated simultaneously when B1 (main warning light) is activated.

Enter Programming Mode 1 and configure B3 Setting as the following table:

#	INDICATOR LIGHT	DESCRIPTION
1	●○○○○○○○○●	Permanent switch, activated upon the power is ON
2	●●○○○○○○○○●	ON/OFF switch
3	●●●○○○○○○○○●	Momentary switch
4 ★Default	●●●●○○○○○○●	<p><i>Grill warning light kill w/o reverting</i> Connect Input 2 to handbrake.</p> <ol style="list-style-type: none"> <li>Activate B1 (main warning light) will activate B3 (grill warning light) simultaneously.</li> </ol> <p><b>NOTE:</b> B3 can be activated only when B1 is activated.</p> <ol style="list-style-type: none"> <li>When B3 is activated, turn on Input 2 (handbrake) will deactivate B3 immediately.</li> </ol> <p><b>NOTE:</b> B3 will not revert when Input 2 (handbrake) is off.</p>
5	●●●●●○○○○●	<p><i>Grill warning light kill w/ reverting</i> Connect Input 2 to handbrake.</p> <ol style="list-style-type: none"> <li>Activate B1 (main warning light) will activate B3 (grill warning light) simultaneously.</li> </ol> <p><b>NOTE:</b> B3 can be activated only when B1 is activated.</p> <ol style="list-style-type: none"> <li>When B3 is activated, turn on Input 2 (handbrake) will deactivate B3 immediately. B3 will revert when input 2 (handbrake) is off.</li> </ol>
6	●●●●●●○○○○●	<ol style="list-style-type: none"> <li>Activate B1 (main warning light) will activate B3 (grill warning light) simultaneously.</li> </ol> <p><b>NOTE:</b> B3 can be activated only when B1 is activated.</p> <ol style="list-style-type: none"> <li>B3 is not affected by Input 2</li> </ol>

### B4 Setting (B4 controls Positive Output 4 and Negative Output 2)

- You can use B4 button as a switch that activates auxiliary devices or rear warning lights.

Enter Programming Mode 1 and configure B4 Setting as the following table:

#	INDICATOR LIGHT	DESCRIPTION
1	●○○○○○○○○●	Permanent switch, activated upon the power is ON
2 ★Default	●●○○○○○○○○●	ON/OFF switch
3	●●●○○○○○○●	Momentary switch
4	●●●●○○○○○○●	Connect Input 2 to handbrake. B4 (rear warning light) can be activated automatically only when Input 2 (handbrake) is ON and B1 (main warning light) is activated. Under that circumstance, B4 can be turned on/off manually.
5	●●●●●○○○○●	1. B1 and B4 are mutually exclusive. 2. B4 is not affected by Input 2.
6	●●●●●●○○○○●	When B6 is set as the start button of Scene 2, activate B6 will also activate B1, B3, B4 simultaneously.

### B5 Setting (B5 controls Positive Output 5)

- You can use B5 button as an ON/OFF switch that activates the traffic arrow function (warning/in-out mode). B5 may be set as the start button of Scene 1 to activate siren and all connected warning lights simultaneously. You can also include B5 into Group 1 or Group 2 to activate traffic arrow function mutually exclusive.

Enter Programming Mode 1 and configure B5 Setting as the following table:

#	INDICATOR LIGHT	DESCRIPTION
1	●○○○○○○○○●	Permanent switch, activated upon the power is ON
2 ★Default	●●○○○○○○○○●	ON/OFF switch
3	●●●○○○○○○●	Momentary switch
4	●●●●○○○○○○●	Include B5 into Group 1 button combo. When B6, B7 and B8 are also included in Group 1, B5, B6, B7 and B8 are mutually exclusive.
5	●●●●●○○○○●	Include B5 into Group 2 button combo. When B6, B7 and B8 are also included in Group 2, B5, B6, B7 and B8 are mutually exclusive.
6	●●●●●●○○○○●	Set B5 as the start button of Scene 1. When B5 is activated, B1, B2, B3 and B4 are activated simultaneously. If B5 is the start button of Scene 1 and B6 is the start button of Scene 2, B5 and B6 are mutually exclusive.

### B6 Setting (B6 controls Positive Output 6)

- You can use B6 button as an ON/OFF switch that activates the traffic arrow function (left-arrow mode). B6 may be set as the start button of Scene 2 to activate all connected warning lights simultaneously. You can also include B6 into Group 1 / Group 2 / Group 3 to activate traffic arrow function mutually exclusive.

Enter Programming Mode 1 and configure B6 Setting as the following table:

#	INDICATOR LIGHT	DESCRIPTION
1	●○○○○○○○○●	Permanent switch, activated upon the power is ON
2 ★Default	●●○○○○○○○○●	ON/OFF switch
3	●●●○○○○○○○○●	Momentary switch
4	●●●●○○○○○○●	Include B6 into Group 1 button combo. When B5, B7 and B8 are also included in Group 1, B5, B6, B7 and B8 are mutually exclusive.
5	●●●●●○○○○○○●	Include B6 into Group 2 button combo. When B5, B7 and B8 are also included in Group 2, B5, B6, B7 and B8 are mutually exclusive.
6	●●●●●●○○○○●	Include B6 into Group 3 button combo. When B7 and B8 are also included in Group 3, B6, B7 and B8 are mutually exclusive.
7	●●●●●●●○○○●	Set B6 as the start button of Scene 2. When B6 is activated, B1, B3 and (B4) are activated simultaneously. When B5 is the start button of Scene 1 and B6 is the start button of Scene 2, B5 and B6 are mutually exclusive.

### B7 Setting (B7 controls Positive Output 7)

- You can use B7 button as an ON/OFF switch that activates the traffic arrow function (center-out mode). You can also include B7 into Group 1 / Group 2 / Group 3 to activate traffic arrow function mutually exclusive.

Enter Programming Mode 1 and configure B7 Setting as the following table:

#	INDICATOR LIGHT	DESCRIPTION
1	●○○○○○○○○○○●	Permanent switch, activated upon the power is ON
2 ★Default	●●○○○○○○○○○○●	ON/OFF switch
3	●●●○○○○○○○○○○●	Momentary switch
4	●●●●○○○○○○○○●	Include B7 into Group 1 button combo. When B5, B6 and B8 are also included in Group 1, B5, B6, B7 and B8 are mutually exclusive.
5	●●●●●○○○○○○○○●	Include B7 into Group 2 button combo. When B5, B6 and B8 are also included in Group 2, B5, B6, B7 and B8 are mutually exclusive.
6	●●●●●●○○○○○○●	Include B7 into Group 3 button combo. When B6 and B8 are also included in Group 3, B6, B7 and B8 are mutually exclusive.

**B8 Setting (B8 controls Positive Output 8)**

- You can use B8 button as an ON/OFF switch that activates the traffic arrow function (right-arrow mode). You can also include B8 into Group 1 / Group 2 / Group 3 to activate traffic arrow function mutually exclusive.

Enter Programming Mode 1 and configure B8 Setting as the following table:

#	INDICATOR LIGHT	DESCRIPTION
1	●○○○○○○○○●	Permanent switch, activated upon the power is ON
2 ★Default	●●○○○○○○○○●	ON/OFF switch
3	●●●○○○○○○○○●	Momentary switch
4	●●●●○○○○○○●	Include B8 into Group 1 button combo. When B5, B6 and B7 are also included in Group 1, B5, B6, B7 and B8 are mutually exclusive.
5	●●●●●○○○○○○●	Include B8 into Group 2 button combo. When B5, B6 and B7 are also included in Group 2, B5, B6, B7 and B8 are mutually exclusive
6	●●●●●●○○○○●	Include B8 into Group 3 button combo. When B6 and B7 are also included in Group 3, B6, B7 and B8 are mutually exclusive

**PROGRAMMING MODE 2**

**Setting Example: Programming Mode 2**

- Press B2 and B4 for more than 1 second to enter Programming Mode 2.

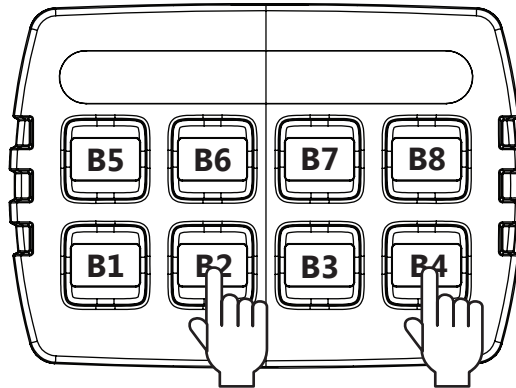

- Press B1 once, Setting #2 is currently selected. Press B1 again to go to Setting #3.

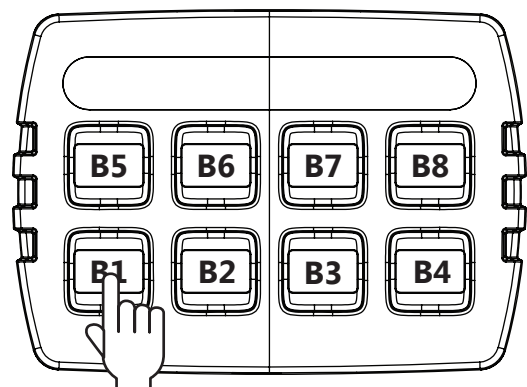
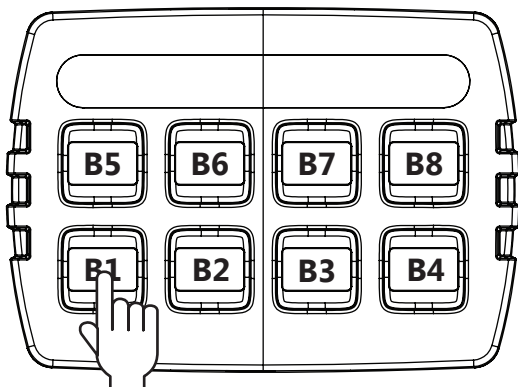



- After finishing setting, press B2 and B4 for more than 1 second to exit and save your configuration.

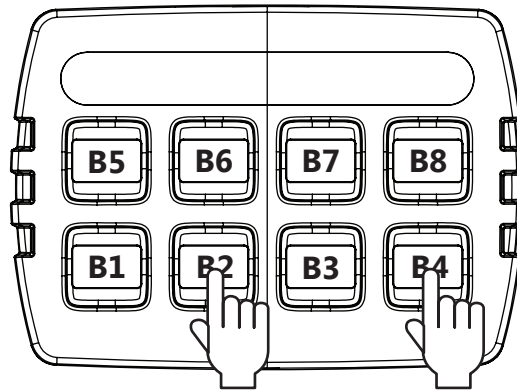

**Standby Mode Setting, B1**

- Under Programming Mode 2, you can change the entry conditions of Standby Mode by B1 Setting.

Enter Programming Mode 2 and configure Standby Mode Setting as the following table:

#	INDICATOR LIGHT	DESCRIPTION
1	●○○○○○○○○●	Automatically enter Standby Mode after 1 minute if no buttons are activated and Input 1 is not activated. Manually enter Standby Mode by pressing B4 for more than 1 second.
2 ★Default	●●○○○○○○○○●	Automatically enter Standby Mode after 15 minutes if no buttons are activated and Input 1 is not activated. Manually enter Standby Mode by pressing B4 for more than 1 second.
3	●●●○○○○○○○○●	Automatically enter Standby Mode after 1 minute if no buttons are activated and Input 1 is not activated. Manually turn off all button functions by pressing B4 for more than 1 second first. The red backlight of B4 blinks for 20 seconds and then automatically enter Standby Mode.
4	●●●●○○○○○○●	Automatically enter Standby Mode after 15 minutes if no buttons are activated and Input 1 is not activated. Manually turn off all button functions by pressing B4 for more than 1 second first. The red backlight of B4 blinks for 20 seconds and then automatically enter Standby Mode.

**B4 Flash Setting, B2**

- Under Programming Mode 2, you can change the flash mode of B4 under Standby Mode by B2 Setting..

Enter Programming Mode 2 and configure B4 Flash Setting as the following table:

#	INDICATOR LIGHT	DESCRIPTION
1 ★Default	●○○○○○○○○●	Set flashing red backlight of B4 to ON (under Standby Mode).
2	●●○○○○○○○○●	Set flashing red backlight of B4 to OFF (under Standby Mode).

**Buzzer Setting, B3**

- Under Programming Mode 2, you can change the buzzer configuration by B3 Setting.

Enter Programming Mode 2 and configure Buzzer Setting as the following table:

#	INDICATOR LIGHT	DESCRIPTION
1 ★Default	●○○○○○○○○●	Set Buzzer to ON
2	●●○○○○○○●	Set Buzzer to OFF

**Backlight Setting, B4**

- Under Programming Mode 2, you can change the Backlight mode by B4 Setting.

Enter Programming Mode 2 and configure Backlight Setting as the following table:

#	INDICATOR LIGHT	DESCRIPTION
1	●○○○○○○○○●	Green ON, Red OFF (Backlight)
2 ★Default	●●○○○○○○●	Red ON, Green OFF (Backlight)
3	●●●○○○○○○●	Red Bright (100%) ON, Red Dim (10%) OFF (Backlight)

**Traffic Arrow Function & Input 2 Setting, B5**

- Under Programming Mode 2, you can change the configuration of Traffic Arrow function and Input 2 (handbrake) by B5 Setting.

NOTE: Setting #2~#4 are available only when B5, B6, B7, B8 are set as Group1 or Group2.

Enter Programming Mode 2 and configure Traffic Arrow Function & Input 2 Setting as the following table:

#	INDICATOR LIGHT	DESCRIPTION
1 ★Default	●○○○○○○○○●	B5, B6, B7 and B8 are not affected by Input 2.
2	●●○○○○○○●	<i>Traffic arrow can be used when handbrake is ON</i> Connect Input 2 to handbrake. 1. If Input 2 is ON, Group 1 / Group 2 / Group 3 are available for activation. 2. If Input 2 is OFF, B5, B6, B7 and B8 will be deactivated compulsively.
3	●●●○○○○○○●	Connect Input 2 to handbrake. 1. If Input 2 is ON, B5 (warning/in-out mode) will be activated automatically. 2. If Input 2 is OFF, B5~B8 will be deactivated compulsively
4	●●●●○○○○●	Connect Input 2 to handbrake. 1. If Input 2 is ON and B1 (main warning light) is activated, B5 will be activated automatically. 2. If Input 2 is OFF or B1 is deactivated, B5, B6, B7 and B8 will be deactivated compulsively.

### Traffic Arrow Indicator Setting, B6

- Under Programming Mode 2, you can change the configuration of Traffic Arrow Indicator by B6 Setting. NOTE: Setting #2~#4 are available only when B5, B6, B7, B8 are set as Group1 or Group2.

Enter Programming Mode 2 and configure Traffic Arrow Indicator Setting as the following table:

#	INDICATOR LIGHT	DESCRIPTION
1 ★Default	●○○○○○○○○●	No Function.
2	●●○○○○○○●	Activate 4 display modes of Indicator Light (for Group 1 / Group 2): <u>NOTE:</u> Group 1 has higher precedence than Group 2.  B5 = In-Out      ●●●○○○○●●● B6 = Left Arrow    ←●●●●●●●●○○ B7 = Center-Out    ●●●○○○○●●● B8 = Right Arrow    ○○○●●●●●●●●
3	●●●○○○○●	Activate 3 display modes of Indicator Light (for Group 3):  B6 = Left Arrow    ←●●●●●●●○○ B7 = Center-Out    ●●●○○○○●●● B8 = Right Arrow    ○○○●●●●●●●●

### Reset to Factory Default Configuration, B3 & B4

- Under Programming Mode 2, you can use B3 and B4 to reset to factory default configuration.
- Press B2 and B4 for more than 1 second to enter Programming Mode 2.

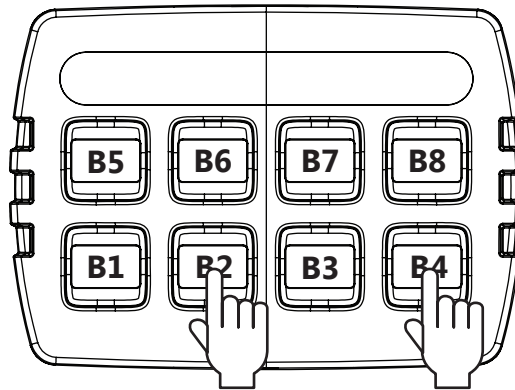

- Press and hold B3 and B4 for more than 5 seconds.

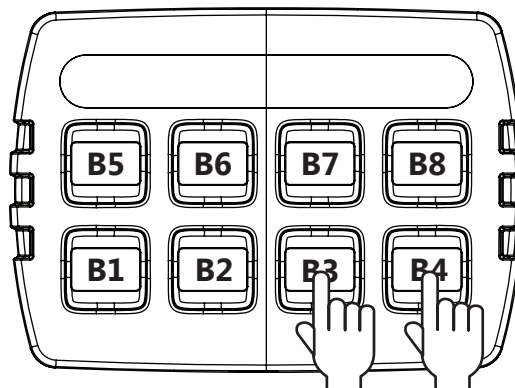

- If EA-8 Controller has been restored to factory default configuration successfully, the controller will return to operation mode (after "beep" for three times and green backlight is ON).

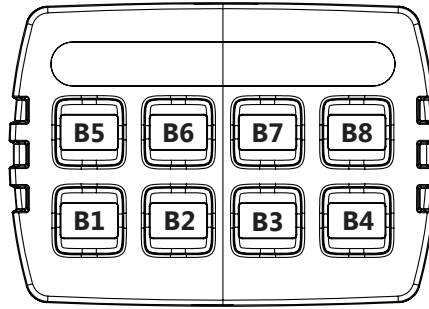

**Button Combo: Group 1**

- If the B5, B6, B7, B8 are configured in the Group 1, they are mutually exclusive and only one button can be activated at the same time.
  - B5 controls Positive Output 5.
  - B6 controls Positive Output 6.
  - B7 controls Positive Output 6 and 8.
  - B8 controls Positive Output 8.
- NOTE: Positive Output 7 is permanent positive output.

**Button Combo: Group 2**

- If the B5, B6, B7, B8 are configured in the Group 2, they are mutually exclusive and only one button can be activated at the same time.
- B5 controls Positive Output 5.
- B6 controls Positive Output 6.
- B7 controls Positive Output 7.
- B8 controls Positive Output 8.

**Button Combo: Group 3**

- If the B6, B7, B8 are configured in the Group 3, they are mutually exclusive and only one button can be activated at the same time.
- B6 controls Positive Output 6.
- B7 controls Positive Output 6, 7 and 8.
- B8 controls Positive Output 8.

**EA-8 DUPLICATOR INSTRUCTIONS**

**Placement of Duplicator Decals**



1. The duplicator is shipped without any button decals installed.
2. Apply a "Copy" decal on B8 and a "Paste" decal on B4.

## EA-8 Duplicator (ETDUE801) Operating Instructions

1. Configure an EA-8 System: User will use EA-8 Control Panel to configure the EA-8 Power Module from the Instruction Manual. Once the configuration is finished, it is ready to copy. Unplug the EA-8 Control Panel and set to the side.

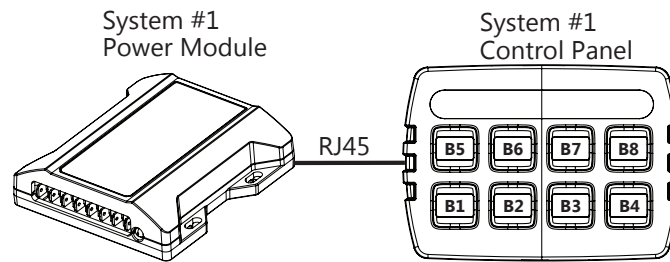

2. Copy Configuration: Plug in EA-8 DUPLICATOR into the RJ45 Jack. Make sure system is powered and IGN is ON. Press and HOLD B8 for 3 sec. to copy the System configuration. The 10 AMBER LEDs will show progress (moving Left to Right) and B8 will turn Red while copying the configuration. Once complete, there are 2 beeps and Button B5 LED will turn RED to indicate a configuration is loaded. The configuration is copied and you may unplug the EA-8 DUPLICATOR. Then plug RJ45 cable back into the EA-8 Control Panel and fasten the mount.

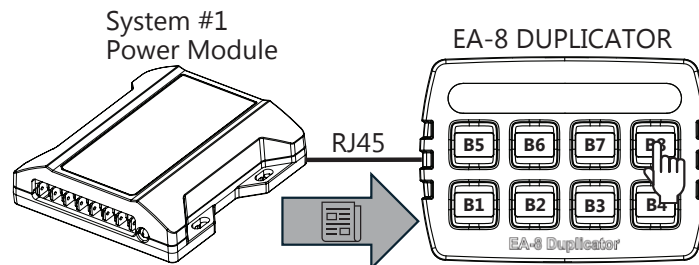

3. Paste Configuration: With previous configuration copied into the EA-8 DUPLICATOR, go to another installation. Unplug the RJ45 Cable from EA-8 Control Panel and plug in the EA-8 DUPLICATOR. Make sure system is powered and IGN is ON. Press B4 to paste the configuration into the current installation. The 10 AMBER LEDs will show progress (moving Right to Left) and B4 will turn Red while pasting the configuration. Once complete there are 2 beeps and, B4 LED will return to GRN. Note, it is expected that the EA-8 system will have the same installation wiring as the one being copied from.

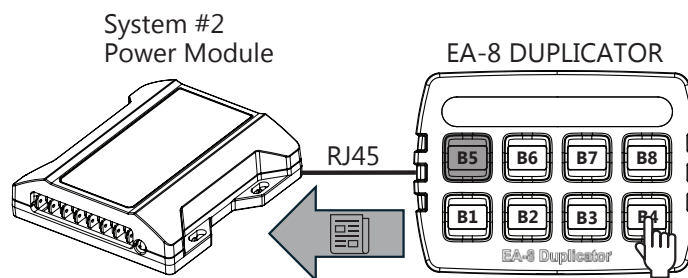

4. Plug System Control Panel back into system: The configuration is copied and you may unplug the EA-8 DUPLICATOR. Then plug RJ45 cable back into the EA-8 Control Panel and fasten the mount. This installation is now complete. You may repeat steps 3 & 4 to duplicate this configuration into other installations.

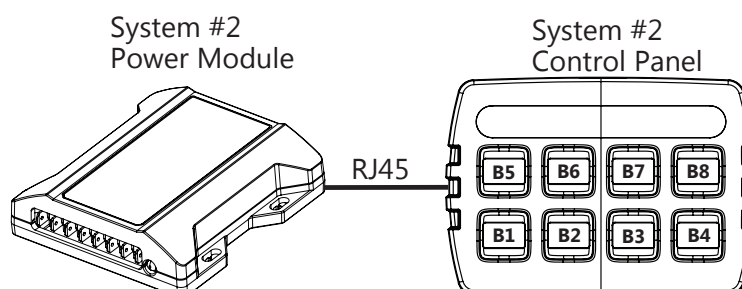

## WARRANTY & RETURN GOODS PROCEDURE

### WARNING MESSAGES - PLEASE READ:

**WARNING** - DRILLING ANY HOLES INTO THE SIREN IS NOT RECOMMENDED! THE RISK OF DAMAGING INTERNAL COMPONENTS AND THE RESULTING FAILURE OF THE SIREN WILL VOID ANY WARRANTY OF THIS PRODUCT.

**WARNING** - CARE MUST BE TAKEN WHEN DRILLING THROUGH THE VEHICLE NOT TO DRILL INTO ANY EXISTING WIRING AND CHECK BOTH SIDES OF THE MOUNTING SERVICE PRIOR TO DRILLING. DE-BURR ANY HOLES AND REMOVE ANY METAL SHARDS OR REMNANTS. INSTALL GROMMETS INTO ALL WIRE PASSAGE HOLES.

**WARNING** - ROUTE WIRES ONLY IN LOCATIONS THAT ARE NOT SUBJECTED TO POTENTIAL WEAR. MAKE SURE TO AVOID ROUTING WIRES IN THE DEPLOYMENT AREA OF YOUR AIR BAG. REFER TO YOUR VEHICLE OWNER'S MANUAL FOR AIR BAG DEPLOYMENT ZONES.

**WARNING** - ALL CUSTOMER SUPPLIED POWER WIRES CONNECTING TO THE POSITIVE (+) OR NEGATIVE (-) BATTERY TERMINAL OR LOCAL CHASSIS GROUND (-) MUST BE SIZED TO SUPPLY AT LEAST 125% OF THE MAXIMUM CURRENT AND PROPERLY FUSED AT THE POWER SOURCE WITH APPROPRIATELY RATED FUSE.

### WARRANTY RETURN PROCESS:



Please scan QR code or visit  
<https://soundoffsignal.com/support-page/returns/>

Alternatively contact your SoundOff Signal Sales Representative, Customer Services staff or our Technical Department (800.338.7337) for a RMA #, Return Merchandise Authorization Number.

The following information is required for issuance of the RMA #:

- Reason for returning the product\*
- Address where replacement product is to be shipped\*
- Telephone number where you may be reached\*
- SoundOff Signal invoice number on which product was purchased\*\*
- SoundOff Signal part number and serial number\*\*
- E-mail address where RMA # should be e-mailed\*\*
- Fax number where RMA # should be faxed\*\*

\* RMA # will not be given without this information.

\*\* If available, please provide this information.

SoundOff Signal will NOT accept returns without an RMA #. Each RMA # is good for only one (1) return and will expire (30) days after the date it was issued. Products must be shipped back to SoundOff Signal and the RMA # clearly marked on the outside of the package near the shipping label. Please use the following address on your shipping label:

SoundOff Signal  
 ATTN: RMA # / Technical Services  
 3900 Central Parkway  
 Hudsonville, MI 49426

### WARRANTY EXCLUSIONS:

Shipping & Handling, labor and service fees are non-refundable. SoundOff Signal is not liable for any damage due to installation or personal injury as a result of using SoundOff Signal product.

### WARRANTY FORFEITURE:

Warranty will not be granted if the Warranty Return Policy & Procedure rules are not strictly followed. Physical damage resulting from customer abuse will void warranty. Warranty will also be voided if any SoundOff Signal and/or manufacturer serial tags, product stickers, seals, or the like, are removed, altered or tampered with. Returned product that is damaged by shipping via the RMA # procedure is not the responsibility of SoundOff Signal.

Document effective date on cover and below supersedes previously dated policies and statements.

There are no other warranties, expressed or implied, including, but not limited to, any implied merchantability or fitness for a particular use. SoundOff Signal reserves the right to modify this warranty statement at any time; or to discontinue, modify, or upgrade any products of its manufacture with design improvements without prior notice.