

INSTALLATION INSTRUCTIONS

A500 SERIES SIREN



DANGER!

- Sirens provide an essential function of an effective audio / visual warning system. However, sirens are only short range secondary devices. The use of a siren does not insure that all drivers can or will abide by or react to an emergency warning signal, especially at high rates of speeds or long distances. The operator of the vehicle must never take the right of way for granted and it is the operator's responsibility to proceed safely.
- The effectiveness of this siren system is highly dependent on the correct mounting and wiring. The installer must read and follow the manufacturer's installation instructions and warnings in the manual. The vehicle operator should verify the siren system is securely fastened to the vehicle and properly functioning.
- Effective sirens generate loud sound pressure levels that can potentially cause hearing damage. Installers and those around the vehicle need to be aware of the dangers and wear hearing protection whenever the siren system is operating. Vehicle operators and occupants should assess their exposure to siren noise and determine what steps need to be taken to prevent hearing damage.
- The siren system is intended for use by authorized personnel only. It is the user's responsibility to ensure they understand and operate the emergency warning devices in compliance with all applicable city, state, and federal laws and regulations. SoundOff Signal assumes no liability for any loss resulting from the use.

WARNING

- Sirens produce loud sounds that may damage hearing:
 - Roll up windows.
 - Wear hearing protection.
 - Use only for emergency response.
 - Avoid exposure to siren sound outside of vehicle.

**IMPORTANT NOTICE TO INSTALLER:**

- Make sure to read and understand all instructions and warnings before proceeding with the installation of this product. Ensure the manual and all warning cards are delivered to the end user of this equipment.
- HIGH CURRENT interconnects must be properly terminated. Poor crimp quality can cause heat build-up and fire. Follow crimp connector manufacturer instructions.
- DO NOT use system to disconnect headlights, brake lights or other safety equipment.
- Unit may become hot to touch during normal operation.
- Failure to properly install connectors, fuses or wiring may cause vehicle failure or fire.
- Installation must only be performed by trained technician. Installer must determine vehicle wiring configuration and proper integration of system.
- Use proper wire gauge. All power wires connecting to positive (+) or negative (-) battery terminal or local chassis ground (-) must be sized to supply at least 125% of max. current and properly fused at power source.
- Install protective grommets when routing wire through firewall or metal.

WARNING

- DO NOT install this product or route its wires in the air bag deployment area. Doing so may cause damage to or reduce effectiveness of the air bag, or create projectile that could cause serious injury or death. To determine air bag deployment area refer to vehicle manufacturer's manual.

NOTICE:

- Installers and users must comply with all applicable federal, state and local laws regarding use and installation of warning devices.
- Improper use or installation may void warranty coverage.
- To review our Limited Warranty Statement & Return Policy for this or any SoundOff Signal product, visit our website at <https://soundoffsignal.com/warranty>.
- If you have questions regarding this product, contact Technical Services, Monday - Friday, 8 a.m. to 5 p.m. ET at 1.800.338.7337 (press #4).
- Questions or comments that do not require immediate attention may be emailed to techgroup@soundoffsignal.com.

Table of Contents

Introduction 4

Technical Specifications 4

Mounting 4

Siren Functions / Controller Layout Information 5

Amplifier Layout Information 6

Electrical Installation / Main Siren Harness / Speaker Siren Harness 7 - 8

Wiring Diagrams 9

Horn Ring Wiring Diagram / Horn Ring Function Table 10

Programming Siren & Aux Button Functions / DIP Switch Settings 11 - 13

NOTE: ENSURE SIREN IS IN STANDBY MODE FOR ALL PROGRAMMING STEPS, IGNITION ON, POWER ON CONTROL PANEL ACTIVE. ALL PROGRAMMING FUNCTIONS WILL BE LOCKED AFTER 20 MINUTES FROM IGNITION ON. TO PROGRAM AFTER IGNITION ON FOR 20 MINUTES, IGNITION MUST BE RESTARTED TO RESTORE PROGRAMMING ACCESS.

Siren Tone Defaults 14

Siren Tone List / HF Tone Scroll 15

Warranty Information 16

A500 100W/200W CONTENTS	
QTY	COMPONENT
1	SIREN UNIT
1	HANDHELD CONTROLLER
1	BRACKET - HANDHELD REMOTE HOLSTER
4	3.5X20MM STAINLESS STEEL, SELF TAPPING SCREW
1	HANDHELD MOUNTING FOAM
1	4 PIN POWER HARNESS
1	4 PIN SPEAKER HARNESS (100W) OR (200W)
1	16 PIN I/O HARNESS
4	3/16"X3/4" STAINLESS STEEL, SELF TAPPING SCREW
4	5.5X10MM LOCK WASHER
1	RJ45 COUPLER
1	4M RJ45 CABLE
1	SIREN OPERATION WARNING CARD
1	WARNING CARD
1	USER WARNING STICKER
1	AUXILIARY BUTTON LEGENDS
1	INSTALLATION INSTRUCTION SHEET

TECHNICAL SPECIFICATIONS		
Overall Dimensions:	MAIN CONTROL UNIT Height: 48.1mm (1.89") Width: 154mm (6") Depth: 181.6mm (7.1")	CONTROLLER Height: 25mm (0.98") Width: 63.5mm (2.5") Depth: 126.9mm (5")
Input Voltage:	10 - 30VDC (negative ground)	
Operating Temperature:	-40°C to +65°C	
Diagnostic LED:	Speaker Normal Operation, Output Speaker Wire Short Circuit, Speaker Open Circuit	
Siren		
Input Current	9.5 Amps @ 13.6 VDC (100W Speaker) 19 Amps @ 13.6 VDC (2 x 100W speakers)	
Standby Current Ignition OFF:	<1mA	
Output Power:	1x100W RMS Max (11 Ohm speaker) 2x100W RMS Max (11 Ohm speaker)	
Audio Frequency:	300 - 10,000Hz	
Siren Frequency:	500Hz - 2000Hz	
High Voltage Protection:	Limits to <36V If siren tone is in progress, sound will continue during over-voltage. New siren tone will not activate if voltage is >36V	
Low Voltage Shutdown:	Voltage <9.0V will cause siren output to cease and will resume when system voltage is >9.5V	
	Auxiliary Input connection for remote manual or Hands Free operation	
Speaker Protection:	Shorted, Open: Stop output signal, preserve Amp	
Certifications	SAE J1849*, CA TITLE 13* ECE R10, CISPR25 CLASS 1	
Lighting Control		
Level 1-2-3 Output Relays:	3x 8A max each circuit, total current not to exceed 25Amps. Short circuit protected by 10A ATO Fuse	
AUX Button Relays:	6 x 0.20Amp max each circuit / 2 of the 6 available outputs can be configured for single button arrow control. Short circuit protected by internal auto-resettable fuse (non-serviceable)	

*With SoundOff 100J, 100U, 100N siren speakers

INTRODUCTION

Thank you for choosing to equip your vehicle with SoundOff Signal's A500 Series Siren. The A500 is a compact siren and lighting controller to meet the basic functions required for emergency vehicles.

The A500 Siren and Lighting Controller features include:

- Up to 20 selectable tones
- Horn & Manual button
- Operates up to 2 x 100W speakers
- Hands free operating mode
- Horn ring transfer input
- 3 x 8AMP Outputs (Level 1, 2 & 3)
- 6 x 0.2AMP Aux Outputs
- Single Button Arrow Control with Indicator LEDs

SoundOff Signal is excited to be your partner for safety and we offer industry-leading service and support to all our products. After fully reviewing these instructions, please contact us should you have questions or concerns about the installation or use of this product.

OPERATING MODES

The primary Siren operating modes are User Selectable Tone, Yelp, Wail, Radio, PA, Horn Override, and a push-button Manual Override are available in all modes.

Lighting modes include Levels 1,2 and 3 plus Aux buttons 1-6. Aux buttons 1-6 can be configured to be Multi press Arrow, latched, momentary or 8 second timed. The outputs for Levels 1-3 are 8AMPs per level.

MOUNTING

Siren Installation

1. Choose a sturdy location to mount the Siren Unit. (Ensure the siren amplifier / relay unit is mounted in dry, protected environment).
2. Use the Siren Unit as a template and mark the four holes to be drilled.
3. Use a 1/8" drill bit to drill the mounting holes.
4. Install the Siren Unit with the four 3/16" x 3/4" hex-wash head self drill screws and lock washers provided.

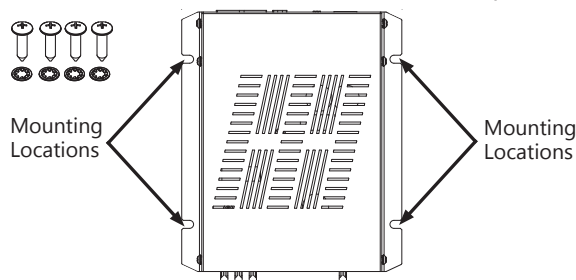

Handheld Controller Bracket Installation

1. Choose a location convenient to the operator to mount the bracket and insure that it is away from any air bag deployment areas.
2. Using the bracket as a template, mark the four holes to be drilled.
3. Using a 1/8" drill bit, drill the four mounting holes.
4. Place the Foam backing behind the Handheld Controller mounting bracket and line up with holes drilled.
5. Install the four 3.5mm x 20mm self tapping screws provided with the bracket until foam starts to compress. **DO NOT OVER-TIGHTEN**

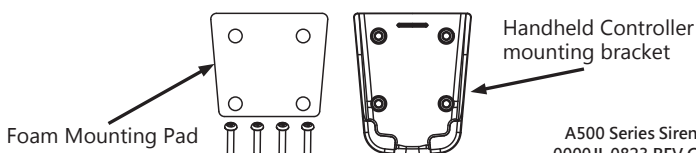

SIREN FUNCTIONS

HAND HELD CONTROLLER

SIREN BUTTON: The 1st press and release will play WAIL tone, the 2nd press and release will play YELP tone, the 3rd press and release will play TONE3 tone, and the 4th press and release will return to WAIL. Press and HOLD for 3 seconds to turn off SIREN Button.

RR (RADIO RE-BROADCAST) BUTTON: Toggle operation. A press and release will activate RR function, the RR signal is Amplified to Speakers. The RR function overrides the SIREN function and will shut off any active SIREN tone. A press and release again will deactivate the RR signal and put siren in Standby Mode.

PA BUTTON: Momentary operation. When PA is pressed the PA Mic signal is amplified to speakers, overrides any active SIREN tones, RR mode, or simultaneous HRN or MAN button presses. When PA is released the siren will automatically switch back to the last active siren mode of operation.

POWER BUTTON: A press and release will shut off any active tone. When press and hold for 5 sec the Sirens is put in Sleep mode. When press and hold for 5 sec again the Siren wakes up in Standby Mode. Ignition cycle will always wake Siren up in Standby Mode. If Ignition input is inactive, press and hold for 5 sec will wake up the Siren in Standby Mode, Siren will be operational without IGN input.

ARROW LEFT AND RIGHT LEDS: ON when bound button is active, OFF when bound button is deactivated.

AUX 1 BUTTON (Default is Multi-Press Arrow): Turns AUX-1A Output ON when activated. Programmable for Toggle, Momentary, 8 second timer, or activate Arrow LEDs. When programmed to Arrow Activate, the button will be a multi press, press 1 = Out 1A & Arrow L, press 2 = Out 1B & Arrow R, press 3 = Out 1A & 1B & Arrow L & R, press 4 = All OFF. **AUX-6 will default to HF Mode if Multi-press mode selected.**

AUX 2 - 5 BUTTON (Default Toggle): When pressed Turns AUX Output ON when activated. Programmable for Toggle, Momentary, 8 second timer.

HORN BUTTON (Default Toggle): Momentary operation. When pressed, HORN tone plays, tone immediate OFF when released Overrides any active SIREN tone, RR and MAN if pressed simultaneously.

3 BUTTON: A press and release will activate LVL Outputs 3, 2 & 1. If Auto Siren is enabled, then SIREN WAIL tone will be enabled. When pressed and released again, this will deactivate buttons 3, 2 & 1. If Auto Siren is enabled, then SIREN tone will turn OFF and put Siren back into Standby Mode.

1 BUTTON: A press and release will activate LVL Output 1, and turn buttons 3 & 2 OFF if either are already active. If Auto Siren is enabled, then any active SIREN tone will Turn OFF. When press and release again, will deactivate button 1.

2 BUTTON: A press and release will activate LVL Outputs 2 & 1, and turn button 3 OFF if already active. If Auto Siren is enabled, then any active SIREN tone will Turn OFF. When pressed and released again, this will deactivate buttons 2 & 1.

0 BUTTON: A press and release will deactivate any of the 3, 2, or 1 buttons. If Auto Siren is enabled, then any active SIREN tone will Turn OFF.

SPEAKER 1 & 2 FAULT LEDS: ON when speaker(s) are active, OFF when faulted or deactivated. *More information below

AUX 6 BUTTON HF MODE (Default Toggle): Turns AUX-1B Output ON when activated. Programmable for Toggle, Momentary, 8 second timer, HF Mode. Toggle operation. A press and release will activate the HF (Hands Free) mode. HF mode is the same as Standby mode, but Horn-Ring input and MAN button can activate the siren (and Level 3 button automatically) and be used to cycle through the HF Tone Scroll List. A press and release again will deactivate the HF function and put siren in Standby Mode. **Exception handling: If AUX 1 is NOT Arrow, and AUX 6 is HF mode, then AUX1B-output will output according to HF mode ON or OFF.**

MAN BUTTON (Default Momentary): Momentary operation. When pressed, MANUAL WAIL tone plays, tone immediate OFF when released, overrides any active SIREN tone or activated RR override tone when RR button is activated.

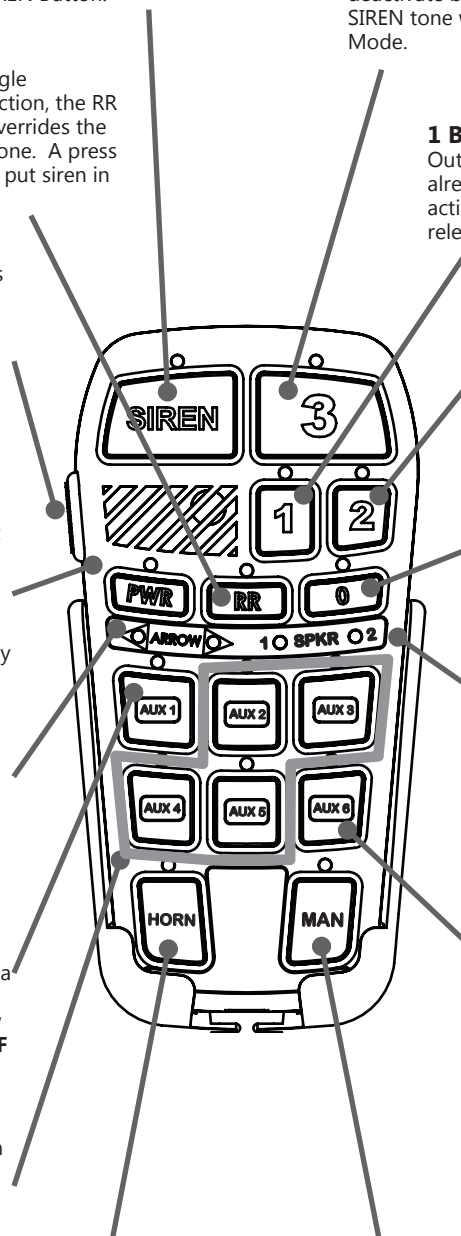

SIREN LAYOUT INFORMATION

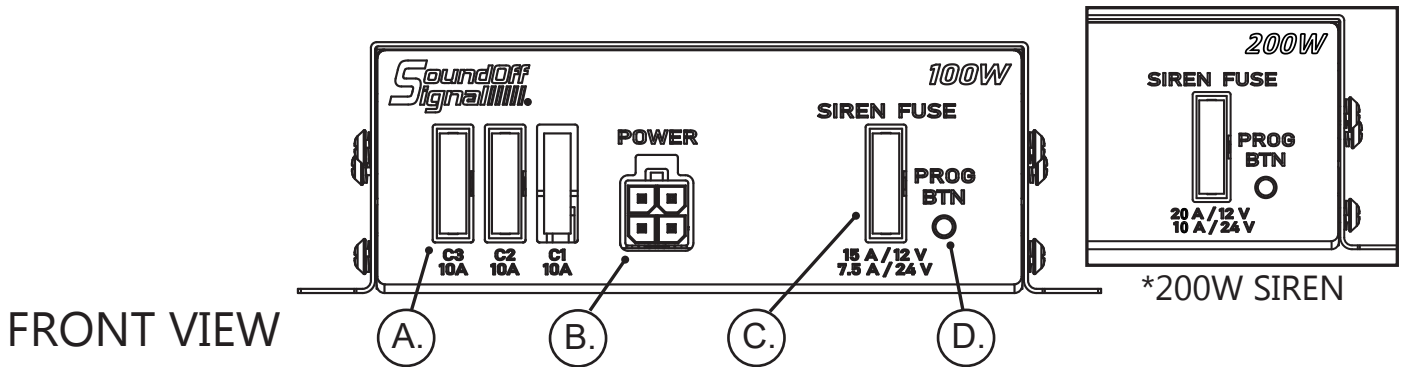

FRONT VIEW

- A. LEVEL 1,2,3 FUSE LOCATIONS:** 10AMP
- B. MAIN SIREN POWER WIRE HARNESS** (page 9. for more details)

- C. MAIN SIREN AMP FUSE LOCATION:**
 100W - 15AMP (12V) / 7.5AMP (24V)
 *200W - 20AMP (12V) / 10AMP (24V)
- D. PROGRAM BUTTON:** Button to change settings (page 11. for details)

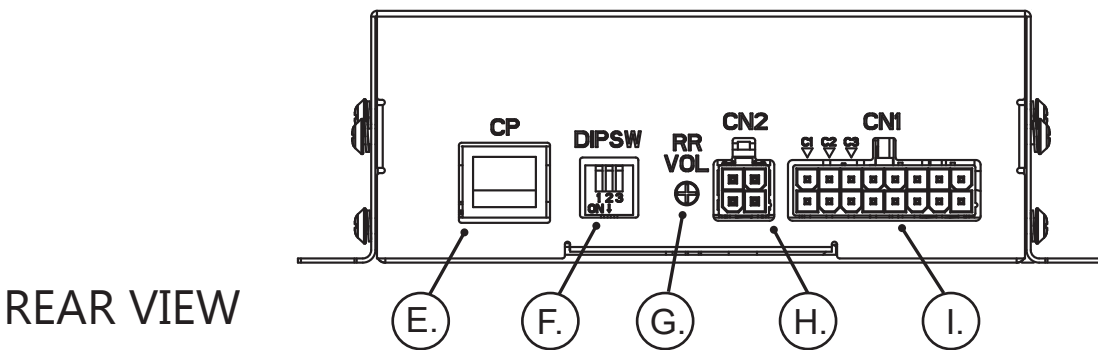

REAR VIEW

- E. CONTROL PANEL PORT**
- F. DIP SWITCHES:** Allows changes to Park Kill input polarity, Horn Ring input polarity and CA Title 13 Mode. (page 10. for more details)
- G. RADIO REBROADCAST VOLUME:** Adjust the volume for radio rebroadcast.

- H. SPEAKER WIRE HARNESS:** Harness for the Siren Speakers. (page 8 & 9. for details)
- I. MAIN SIREN WIRE HARNESS:** Harness for the Siren Controls and Lighting Outputs. (pages 7 & 9. for details)

ELECTRICAL INSTALLATION / MAIN SIREN HARNESS

SIREN HARNESS				
PIN	FUNCTION	WIRE COLOR	I/O	WIRE SIZE
1	HORN RING IN	WHITE/BLACK	INPUT	18AWG
2	HORN RING OUT	WHITE	OUTPUT	18AWG
3	AUX 5 OUTPUT (0.2 Amps)	BLACK	OUTPUT	18AWG
4	AUX 4 OUTPUT (0.2 Amps)	GREY	OUTPUT	18AWG
5	AUX 3 OUTPUT (0.2 Amps)	BROWN	OUTPUT	18AWG
6	AUX 2 OUTPUT (0.2 Amps)	ORANGE	OUTPUT	18AWG
7	AUX 1B OUTPUT (0.2 Amps)	RED/WHITE	OUTPUT	18AWG
8	AUX 1A OUTPUT (0.2 Amps)	RED	OUTPUT	18AWG
9	IGNITION	ORANGE/BLACK	INPUT	18AWG
10	NEUTRAL SAFETY SWITCH INPUT	YELLOW	INPUT	18AWG
11	AUXILIARY INPUT	VIOLET	INPUT	18AWG
12	RADIO REBROADCAST INPUT	BLUE	INPUT	18AWG
13	RADIO REBROADCAST INPUT	BLUE	INPUT	18AWG
14	LEVEL 3 OUTPUT (8AMPS)	YELLOW	OUTPUT	16AWG
15	LEVEL 2 OUTPUT (8AMPS)	GREEN	OUTPUT	16AWG
16	LEVEL 1 OUTPUT (8AMPS)	BLUE	OUTPUT	16AWG

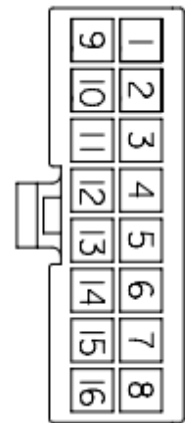

Rear View

Horn Ring Input: (White/Black Wire)

The input will allow the operator to control the siren function by pressing the vehicle horn ring. Refer to wiring diagram (Pg. 10) for details on how to connect the horn ring input wires to the vehicle's horn ring wiring. If this feature is required, the installer needs to determine if the signal wire from the horn ring is switching the +V or ground side of the circuit. Refer to programming instructions on how to set the horn ring polarity on the siren. Extend the horn ring input wires from the siren amplifier to the horn ring switch using a minimum of 18ga wire. The horn ring circuit is capable of handling a maximum of 0.2 amps. More info on Horn Ring Functions on Page 10.

AUX 2-5 Outputs: (Black, Grey, Brown & Orange Wires)

AUX Buttons 2-5 turn on Outputs 2-5 when activated. The output will behave per programed setting.

AUX 1A Output: (Red Wire)

Aux 1A is active when AUX 1 Button is set to Multi-Press Arrow and pressed 1 time. This would be the output for Left Arrow activation. When Multi-Press is deactivated Aux 1A will default to Button AUX 1 Output. The output will behave per programed setting.

AUX 1B Output - HF Mode: (Red/White Wire)

Aux 1B is active when AUX 1 Button is set to Multi-Press Arrow and pressed 2 times. This would be the output for Right Arrow activation. When Multi-Press is deactivated Aux 1B will default to HF (Hands Free) mode. When in HF mode the AUX 6 button will activate output 1B.

Ignition Input: (Orange/Black Wire)

Ignition Input (+12V) will turn on the device and activate control panel back-lighting.

Neutral Safety Switch Input: (Yellow Wire)

The input will silence the siren tone when the input wire is activated. The input is typically connected to the transmission neutral safety switch. If this feature is required, the installer needs to determine if the signal wire from the neutral safety switch is switching the +V or ground side of the circuit. Refer to the programming instructions on how to set the neutral safety switch polarity on the siren. Extend the neutral safety switch input wire from the siren amplifier to the vehicle neutral safety switch using a minimum 22ga. Wire. Neutral safety switch input Low is < 5Vdc.

ELECTRICAL INSTALLATION / MAIN SIREN HARNESS CONTINUED

Auxiliary Input: (Violet Wire)

The input is an optional input which will remotely activate the siren when the auxiliary input wire is connected to ground. If this feature is needed, connect the auxiliary input wire to a switch which provides a ground connection when activated. *Neutral safety switch input disables any active auxiliary tone. The auxiliary tone can be reactivated when Neutral safety switch input is activated by toggling the Auxiliary Input.

Radio Rebroadcast Input: (Blue Wires)

The 2 – 18ga blue wires on the 16 pin Molex connector are used to connect your two-way radio's external speaker through the siren amplifier and broadcast through the warning siren speaker (optional). Radio Rebroadcast will not work with remotely amplified speakers due to the signal amplitude being too low.

1. Locate the 2 wires that connect the external speaker to the two-way radio.
2. T-tap one blue wire into one of the external speaker wires. T-tap the other blue wire into the other external speaker wire (If the blue wires need to be extended, use a minimum of 20ga. wire).
3. The Radio Rebroadcast volume must be adjusted prior to placing vehicle into service. Set the volume of the two-way radio to the normal operating level.

4. Press the RR button, with a small screwdriver, adjust the radio rebroadcast volume potentiometer located on the back of the siren amplifier to obtain the proper volume out the speaker (Turn potentiometer clockwise to increase volume and counter-clockwise to decrease volume).

Level 3 Output: (12AWG Yellow Wire)

When #3 Button is activated Output 3 will be active and added to Outputs 1 & 2. Level 3 Output has a max load of 8 Amps.

Level 2 Output: (12AWG Green Wire)

When #2 Button is activated Output 2 will be active and added to Output 1. Level 2 Output has a max load of 8 Amps.

Level 1 Output: (12AWG Blue Wire)

When #1 Button is activated Output 1 will be active. Level 1 Output has a max load of 8 Amps.

ELECTRICAL INSTALLATION / SPEAKER SIREN HARNESS

SPEAKER HARNESS				
PIN	FUNCTION	WIRE COLOR	I/O	WIRE SIZE
1	SPEAKER A (-)	ORANGE/BLACK	OUTPUT	18AWG
2	SPEAKER A (+)	ORANGE	OUTPUT	18AWG
3	SPEAKER B (-) (200W)	GREEN/BLACK	OUTPUT	18AWG
4	SPEAKER B (+) (200W)	GREEN	OUTPUT	18AWG

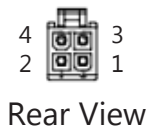

NOTE: SPEAKER B (GREEN/BLACK AND GREEN WIRES) WILL NOT BE POPULATED ON 100 WATT SIREN

Siren Speaker Output: (Orange + Orange/Black Wires), (Green + Green/Black Wires) Use a minimum of 18ga. wire to extend the wires as needed. Connect the Orange wire to the primary Speaker High wire. Connect the Orange/Black wire to the primary Speaker Low wire. On the 200 Watt Siren connect the Green wire to the secondary Speaker High Wire. Connect the Green/Black wire to the secondary Speaker Low Wire.

WIRING DIAGRAM

FRONT WIRE HARNESS

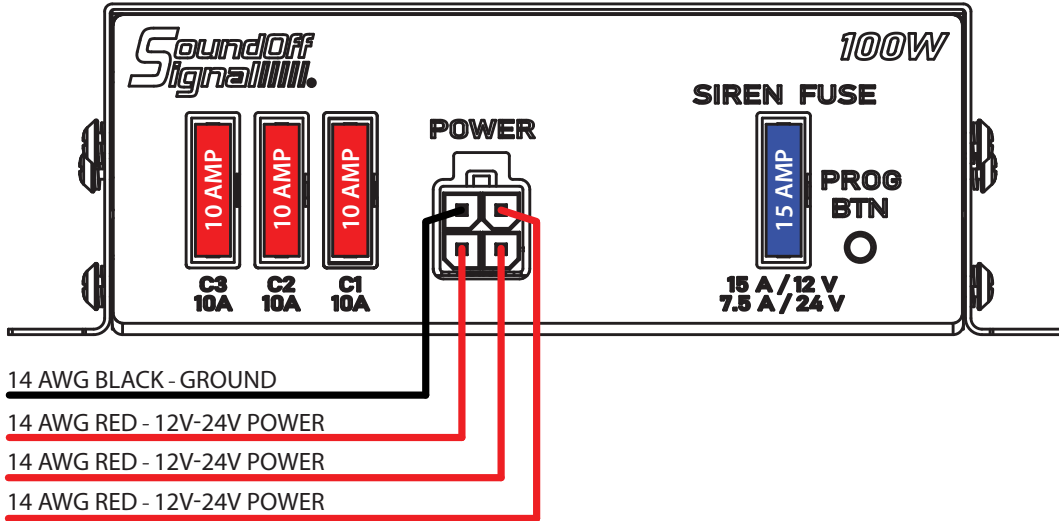

REAR WIRE HARNESSES

Wire capacity requirements for siren amplifier (incoming power)-each supply and ground wire.

0-10 Feet:	16 AWG
10-20 Feet:	14 AWG
20-30 Feet:	12 AWG
30+ Feet:	Consult Factory to determine requirements

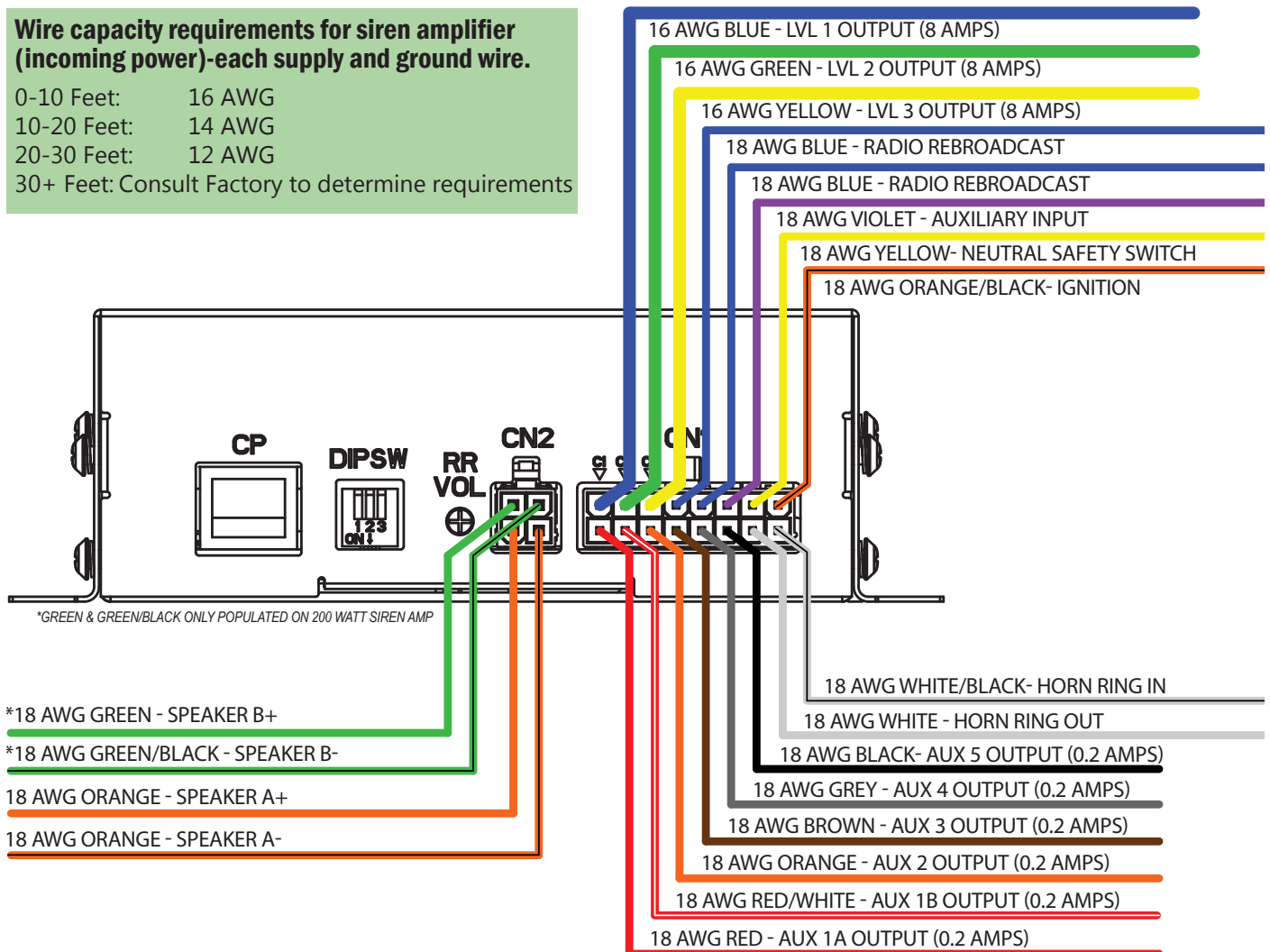

HORN RING WIRING DIAGRAM

*Only necessary when the horn is a **POSITIVE** input and requires more than 0.2 Amps.

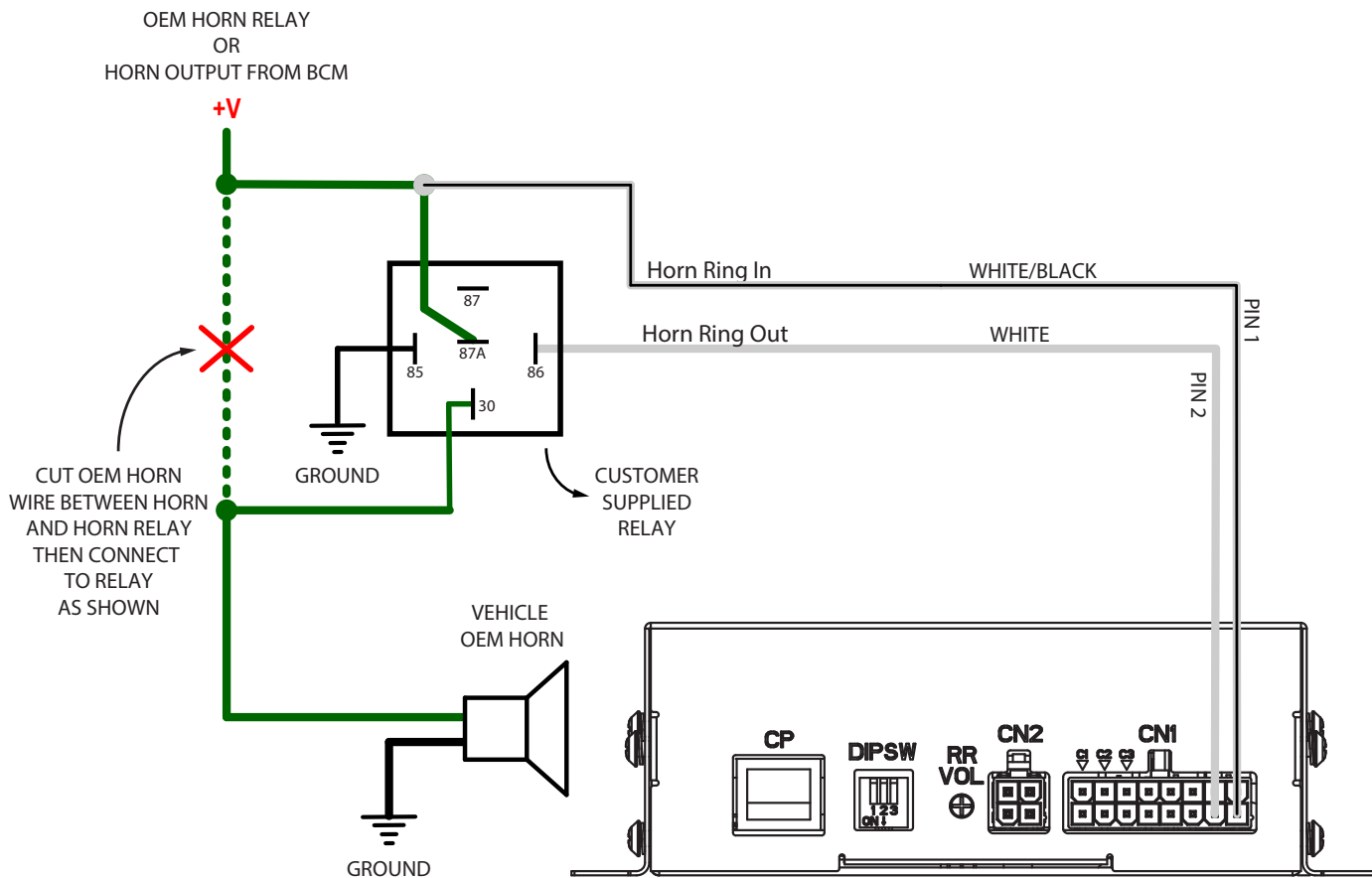

HORN RING INFORMATION

INPUT ACTIVATED	OFF (IGN OFF or PWR OFF)	Standby MODE (*IGN ON, PWR ON, LVL "0")	STANDBY MODE (*IGN ON, PWR ON, (LVL "1, 2 or 3", AUX Active)	RAD	HF	WAIL	YELP	TO NE
Horn Ring Input CA13 OFF	No affect	Produce Horn Tone until release	Produce Horn Tone until release		Single press will activate HF tone, next single press will advance tone scroll list. Double press will stop siren tone. Press and hold will produce Horn Tone until released.	Single press will change to WAIL Override tone, single press again will change back to WAIL tone. Double press will Cancel Tone. Press and hold will produce Horn Tone until released.	Single press will change to YELP Override tone, single press again will change back to YELP tone. Double press will Cancel Tone. Press and hold will produce Horn Tone until released.	*Press will Cycle Back to WAIL Tone (SIREN Button PRESS #1) *Press and HOLD will produce Horn Tone(1) until released. Double press will Cancel Tone (Turn off SIREN BTN)
Horn Ring Input CA13 ON	OFF, No affect	Produce Horn Tone until release	Produce Horn Tone until release		Single press will activate HF tone, next single press will advance tone scroll list. Double press will stop siren tone. On Standby mode or Park kill is activated, Press and hold will produce Horn Tone until released.	Single press will change to WAIL Override tone, single press again will change back to WAIL tone. When Park kill is activated, press and HOLD will produce Horn Tone until released.	Single press will change to YELP Override tone, single press again will change back to YELP tone. When Park kill is activated, press and HOLD will produce Horn Tone until released.	Single press will Cycle Back to WAIL Tone. Double press will Cancel Tone. When Park kill is activated, press and HOLD will produce Horn Tone until released.
Horn Ring Output	OFF, OEM Horn Sounds	ON, OEM Horn Disconnected						

PROGRAMMING

NOTE: ENSURE SIREN IS IN STANDBY MODE FOR ALL PROGRAMMING STEPS, IGNITION ON, POWER ON CONTROL PANEL ACTIVE. ALL PROGRAMMING FUNCTIONS WILL BE LOCKED AFTER 20 MINUTES FROM IGNITION ON. TO PROGRAM AFTER IGNITION ON FOR 20 MINUTES, IGNITION MUST BE RESTARTED TO RESTORE PROGRAMMING ACCESS.

Change Tone for SIREN Button (Wail, Yelp, Tone)

Press SIREN button, to activate tone and select the tone you want to change, first activation is WAIL, press again to activate YELP, press again to activate TONE. Once desired tone is selected to change, Press and release the Programming button on the rear of the siren, the next tone on the list (Tone List for SIREN button Wail, Yelp, Tone) will play. Press and release the Programming button until the desired tone is playing. The tone is saved as soon as the programming button is released.

Change Override Tone for SIREN Button (Wail, Yelp)

Press SIREN button, to activate tone and select the tone you want to change, first activation is WAIL, press again to activate YELP. Once desired tone is selected to change. Press and release the Programming button on the rear of the siren, the next tone on the list (Override Tone List for SIREN button Wail, Yelp) will play. Press and release the Programming button until the desired tone is playing. The tone is saved as soon as the programming button is released.

Change Tone for Hands Free (HF) Mode

Activates Hands Free mode by pressing HF button 6. There are 3 HF cycle positions to program.

1. Press and release the MAN button on the front panel of the siren, Hands Free cycle position 1 will play. Press and release the Programming button on the rear of the siren, the next tone on the list (Tone List for Hands Free) will play. Press and release the Programming button until the desired tone is playing.
2. Press and release MAN button again to advance to HF cycle position 2, then press and release the Programming button until the desired tone is playing.
3. Press and release the MAN button to advance to HF position 3, then press and release the Programming button until the desired tone is playing. The tone is saved as soon as the programming button is released.

Change Tone for MAN Button

Press and hold the MAN button on the front panel of the siren. Press and release the Programming button on the rear of the siren, the next tone on the list (Tone List for MAN Button) will play. Press and release the Programming button until the desired tone is playing. The tone is saved as soon as the programming button is released.

Change Tone for HORN Button

Press and hold the HORN button on the front panel of the siren. Press and release the Programming button on the rear of the siren, the next tone on the list (Tone List for HORN Button) will play. Press and release the Programming button until the desired tone is playing. The tone is saved as soon as the programming button is released.

Change MAN Override Tone for RAD Mode

Press RR Button to activate RAD (Radio Rebroadcast) Mode. Press and hold the MAN button on the front panel of the siren. Press and release the Programming button on the rear of the siren, the next tone on the list (MAN Override Tone List for RAD Mode) will play. Press and release the Programming button until the desired tone is playing. The tone is saved as soon as the programming button is released.

Change Back light Level

Default is Level 6; 1. Press and Hold the 0 Button for 3 seconds. (Will override the AUX1~6 LEDs)

2. Then press Aux Buttons 1-6 to select intensity.

1 = Low Intensity

6 = High Intensity

Level 1 0% (OFF): AUX LEDs ON: 1

Level 2 20%: AUX LEDs ON: 1,2

Level 3 40%: AUX LEDs ON: 1,2,3

Level 4 60%: AUX LEDs ON: 1,2,3,4

Level 5 80%: AUX LEDs ON: 1,2,3,4,5

Level 6 100%: AUX LEDs ON: 1,2,3,4,5,6

PA Volume Setting

Default 3, Press and HOLD 1 and 2 buttons together for 3 seconds, to enter Siren programming mode. Press and Hold PA button to display volume level (AUX LEDs 1-6 will flash the set level) and test volume. AUX buttons 1-6 set PA Volume Level; 1 being the lowest, 6 being the highest. Press a button 1-6 to set the volume level. Volume level is saved as soon as AUX button is pressed. Release PA button and Press RR button to exit programming mode.

When PA button is depressed AUX LEDs Flashing indicate volume level:

Volume Level 1 20%: AUX LEDs Flashing: 1

Volume Level 2 36%: AUX LEDs Flashing: 1,2

Volume Level 3 52%: AUX LEDs Flashing: 1,2,3

Volume Level 4 68%: AUX LEDs Flashing: 1,2,3,4

Volume Level 5 84%: AUX LEDs Flashing: 1,2,3,4,5

Volume Level 6 100%: AUX LEDs Flashing: 1,2,3,4,5,6

See page 12 for more information

PROGRAMMING CONTINUED

NOTE: ENSURE SIREN IS IN STANDBY MODE FOR ALL PROGRAMMING STEPS, IGNITION ON, POWER ON CONTROL PANEL ACTIVE. ALL PROGRAMMING FUNCTIONS WILL BE LOCKED AFTER 20 MINUTES FROM IGNITION ON. TO PROGRAM AFTER IGNITION ON FOR 20 MINUTES, IGNITION MUST BE RESTARTED TO RESTORE PROGRAMMING ACCESS.

DIP Switch Settings

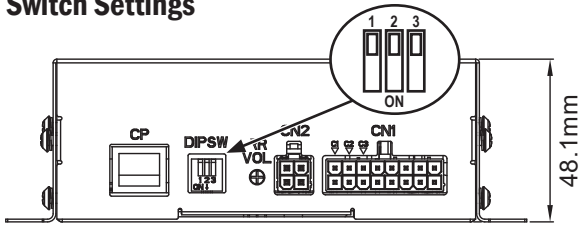

SW 1 Park Kill Input Polarity

- UP (OFF) Default: Park Kill Input Activation by Applying Ground (-)



- DOWN (ON): Park Kill Input Activation by Applying Power (+)



SW 2 Horn Ring Input Polarity

- UP (OFF) Default: Horn Ring Input Activation by Applying Ground (-)



- DOWN (ON): Horn Ring Input Activation by Applying Power (+)



SW 3 To Enable/Disable CA Title 13 Mode

- UP (OFF) Default: CA Title 13 Mode Disabled



- DOWN (ON): CA Title 13 Mode Enabled



To Enable CA Title 13 Mode, move the switch DOWN to the (ON) position. This will activate CA Title 13 Mode which affects Default tones as shown on CA Title 13 Mode Default Tones list, and Applies the following rule to HORN; HORN is NOT allowed to override primary warning tones.

Auto Siren Mode:

Siren ON (Default): Auto Siren On
Siren OFF: Auto Siren Off

To ENTER Siren Functions Programming Mode:

Press & HOLD 1 and 2 Button for 3 seconds.

To adjust PA Volume:
Press PA when in programming mode.

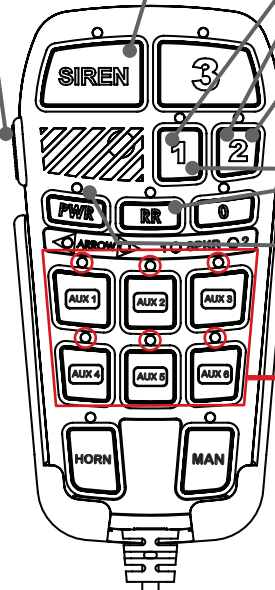

Park Kill Mode:

2 ON (Default): Cancel
2 OFF: Pause

HH Control Panel BEEP:

1 ON: BEEP On
1 OFF (Default): BEEP Off

To EXIT programming mode:
Press RR Button

PWR LED Flashes when in programming mode.

Aux Button LEDs indicate set PA volume level. 1 being the lowest and 6 being the highest. Default level is set to 3

Change Park Kill Mode Configuration

Default: Cancel mode, Press and HOLD 1 and 2 buttons together for 3 seconds, to enter Auto Siren programming mode. PWR LED will flash. 2 LED indicates Park Kill Mode; ON = Cancel, OFF = Pause. Press 2 button to toggle between Park Kill Modes Cancel or Pause. Press RR button to exit programming mode.

Auto Siren Mode

Default ON, Press and HOLD 1 and 2 buttons and together for 3 seconds, Auto Siren programming mode. SIREN LED indicates when Auto Siren Mode is ON or OFF. Press SIREN button to toggle between Auto Siren Mode ON or OFF. Press RR button to exit programming mode.

Change BEEP with Button Press Mode

Default: BEEP OFF, Press and HOLD 1 and 2 BUTTONS together for 3 seconds to enter Auto Siren programming mode. PWR LED will flash. 1 LED indicates BEEP Mode; ON = BEEP ON or OFF = BEEP OFF. Press 1 button to toggle between BEEP Mode ON or OFF. Press RR button to exit programming mode.

PROGRAMMING CONTINUED

NOTE: ENSURE SIREN IS IN STANDBY MODE FOR ALL PROGRAMMING STEPS, IGNITION ON, POWER ON CONTROL PANEL ACTIVE. ALL PROGRAMMING FUNCTIONS WILL BE LOCKED AFTER 20 MINUTES FROM IGNITION ON. **TO PROGRAM AFTER IGNITION ON FOR 20 MINUTES, IGNITION MUST BE RESTARTED TO RESTORE PROGRAMMING ACCESS.**

PWR & 0 LED Flashes when in programming mode.

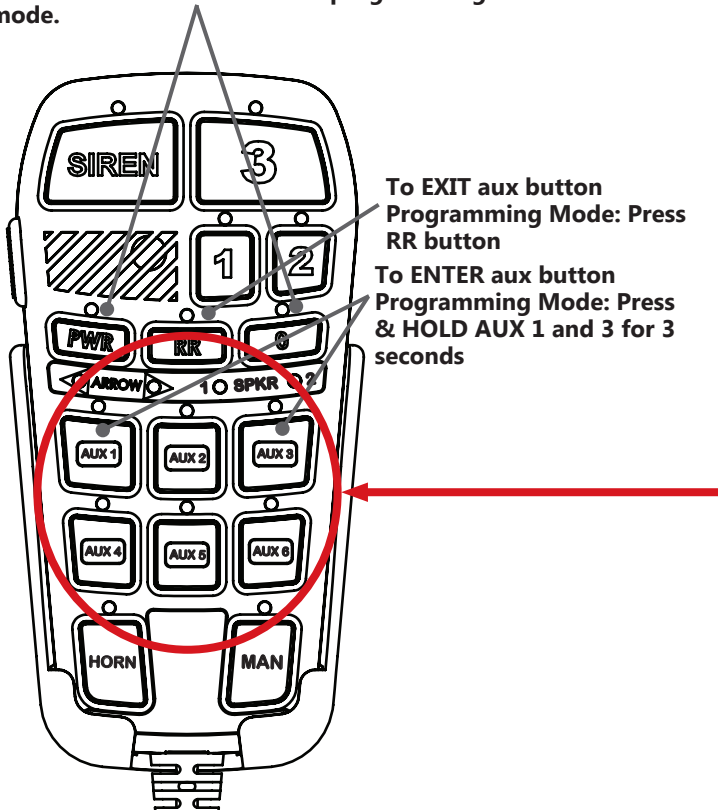

Aux Button Programming

Press and HOLD AUX 1 and AUX 3 together for 3 seconds to enter Aux Button programming mode. PWR LED & 0 Button will flash. Press RR button to exit programming mode.

AUX Button	Programming Modes	AUX Indicator
AUX 1	*Multi Press Arrow Toggle Momentary 8 Sec Timed	Double Flash ON OFF Flash 1s ON / 1s OFF
AUX 2-5	Toggle Momentary 8 Sec Timed	ON OFF Flash 1s ON / 1s OFF
AUX 6	*HF Toggle Momentary 8 Sec Timed	Double Flash ON OFF Flash 1s ON / 1s OFF

■ Indicates DEFAULT setting

*If AUX 1 is set to Multi Press Arrow, then AUX 6 is Locked to HF Mode and cannot be changed. If AUX 1 is any other function, then AUX 6 can be any of the other selectable functions

Restore to Factory Defaults

To reset the Siren to factory default setting, Press and HOLD the Programming button on the rear of the siren for 5 seconds. When the defaults are reset, ALL LEDs on the HH Control Panel will flash 1 sec ON, 1 sec OFF until the Programming button is released. Siren is restored to factory default settings. **Must under Standby mode and Aux1~6 must be off.**

Speaker Diagnostics

- **Speaker Normal Operation**
SPKR indicator LEDs will be ON.
- **Output Speaker Wire Short Circuit**
SPKR indicator LED will be OFF.
Siren Tone will not operate.
Retry only after Siren tone request button is pressed (SIREN, MAN, HRN) or input that activates a tone.
Once issue is fixed, tone will begin.
- **Speaker Open Circuit**
SPKR indicator LED will be OFF

Speaker Diagnostic LEDs

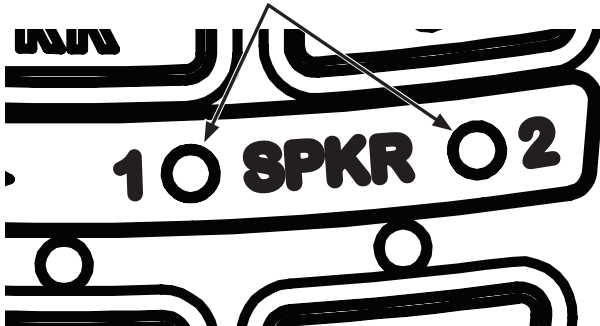

SIREN TONE LIST / HR (HANDS FREE) TONE SCROLL

TONES						
	Tone List for SIREN BUTTON / Wail, Yelp, Tone & AUX Input	Override Tone List for SIREN BUTTON / Wail, Yelp & AUX Input	Tone List for Hands Free	Tone List for HORN Button	Tone List for MAN Button	MAN Override Tone List for RR Mode
Tone OFF	X	X		X	X	X
Wail 1	X	X	X			X
Yelp 1	X	X	X			
Yelp 2	X	X	X			
Piercer	X	X	X			
ALERT A	X	X	X			
HI/LO	X	X	X			
Super HI/LO	X	X	X			
nFORCE Call	X	X	X			
Whoop	X	X	X			
Warble	X	X	X			
Mechanical Wail	X	X	X			
Horn1		X		X		X
Horn2		X		X		X
Horn3		X		X		X
Horn4		X		X		X
Horn5		X		X		X
Horn6		X		X		X
Horn7		X		X		X
Horn8		X		X		X
Horn9		X		X		X
Simulated Mechanical, Immediate OFF when Released				X	X	
Simulated Mechanical, Frequency Decay when Released				X	X	
Manual Wail, Immediate OFF when Released				X	X	X
Manual Wail, Frequency Decay when Released				X	X	X

HF TONE SCROLL	
Tone #	Tone Name
HF 1	WAIL 1
HF 2	YELP 1
HF 3	PIERCER
Return to HF Tone #1	

WARRANTY & RETURN GOODS PROCEDURE

WARNING MESSAGES - PLEASE READ:

WARNING - DRILLING ANY HOLES INTO THE SIREN IS NOT RECOMMENDED! THE RISK OF DAMAGING INTERNAL COMPONENTS AND THE RESULTING FAILURE OF THE SIREN WILL VOID ANY WARRANTY OF THIS PRODUCT.

WARNING - CARE MUST BE TAKEN WHEN DRILLING THROUGH THE VEHICLE NOT TO DRILL INTO ANY EXISTING WIRING AND CHECK BOTH SIDES OF THE MOUNTING SERVICE PRIOR TO DRILLING. DE-BURR ANY HOLES AND REMOVE ANY METAL SHARDS OR REMNANTS. INSTALL GROMMETS INTO ALL WIRE PASSAGE HOLES.

WARNING - ROUTE WIRES ONLY IN LOCATIONS THAT ARE NOT SUBJECTED TO POTENTIAL WEAR. MAKE SURE TO AVOID ROUTING WIRES IN THE DEPLOYMENT AREA OF YOUR AIR BAG. REFER TO YOUR VEHICLE OWNER'S MANUAL FOR AIR BAG DEPLOYMENT ZONES.

WARNING - ALL CUSTOMER SUPPLIED POWER WIRES CONNECTING TO THE POSITIVE (+) OR NEGATIVE (-) BATTERY TERMINAL OR LOCAL CHASSIS GROUND (-) MUST BE SIZED TO SUPPLY AT LEAST 125% OF THE MAXIMUM CURRENT AND PROPERLY FUSED AT THE POWER SOURCE WITH APPROPRIATELY RATED FUSE.

WARRANTY RETURN PROCESS:



Please scan QR code or visit
<https://soundoffsignal.com/support-page/returns/>

Alternatively contact your SoundOff Signal Sales Representative, Customer Services staff or our Technical Department (800.338.7337) for a RMA #, Return Merchandise Authorization Number.

The following information is required for issuance of the RMA #:

- Reason for returning the product*
- Address where replacement product is to be shipped*
- Telephone number where you may be reached*
- SoundOff Signal invoice number on which product was purchased**
- SoundOff Signal part number and serial number**
- E-mail address where RMA # should be e-mailed**
- Fax number where RMA # should be faxed**

* RMA # will not be given without this information.

** If available, please provide this information.

SoundOff Signal will NOT accept returns without an RMA #. Each RMA # is good for only one (1) return and will expire (30) days after the date it was issued. Products must be shipped back to SoundOff Signal and the RMA # clearly marked on the outside of the package near the shipping label. Please use the following address on your shipping label:

SoundOff Signal
 ATTN: RMA # / Technical Services
 3900 Central Parkway
 Hudsonville, MI 49426

WARRANTY EXCLUSIONS:

Shipping & Handling, labor and service fees are non-refundable. SoundOff Signal is not liable for any damage due to installation or personal injury as a result of using SoundOff Signal product.

WARRANTY FORFEITURE:

Warranty will not be granted if the Warranty Return Policy & Procedure rules are not strictly followed. Physical damage resulting from customer abuse will void warranty. Warranty will also be voided if any SoundOff Signal and/or manufacturer serial tags, product stickers, seals, or the like, are removed, altered or tampered with. Returned product that is damaged by shipping via the RMA # procedure is not the responsibility of SoundOff Signal.

Document effective date on cover and below supersedes previously dated policies and statements.

There are no other warranties, expressed or implied, including, but not limited to, any implied merchantability or fitness for a particular use. SoundOff Signal reserves the right to modify this warranty statement at any time; or to discontinue, modify, or upgrade any products of its manufacture with design improvements without prior notice.